

SLSS CANAnalyser Pro Software

CAN-Bus Software for use with Serosys Technologies hardware dongles

Document: V1.2.4.1L - January 2026

Table of Contents

- Users Manual 1
 - 1. Getting started 2
 - 1.1. Hardware 2
 - 1.2. Connector Pinouts 3
 - 2. SLSS CANAnalyser Software 6
 - 2.1. The Main Screen Layout 6
 - 2.2. Message Center Details 8
 - 2.3. Understanding the LEDs on the CAN Dongles 9
 - 2.4. Establishing the Connection Between Software and CAN Dongle 10
 - 2.5. Selecting Your Desired CAN Bus to Monitor 16
 - 2.6. Controlling the Recording / Displaying of CAN Traffic 17
 - 2.7. Selecting the Global Data format to view CAN ID and CAN Data 18
 - 3. Contextual Buttons and Features 18
 - 3.1. Exporting Logged Data 20
 - 3.2. Message Filtering Button 22
 - 3.3. DB button 24
 - 3.4. Database Explorer button (DBC, LDF) 26
 - 3.5. Graphical Analyser Viewer Button 29
 - 3.6. Storing / Recalling Full Sessions Containing all Settings 32
 - 4. Feature Tabs 34
 - 4.1. Incoming CAN Data Feature Tab 34
 - 4.2. CAN Logfile Recorder Feature Tab 36
 - 4.3. Send CAN Messages Feature Tab 36
 - 4.4. Reverse Engineering Feature Tab 41
 - 4.5. Incoming Database Signals Feature Tab 44
 - 4.6. Standalone Send Mode Feature Tab 46
 - 4.7. Send Database Signal Feature Tab 49
 - 4.8. Send LIN Messages Feature Tab 50
 - 5. Other Menu Options 51
 - 5.1. Byte Highlighting 51
 - 5.2. Right-Click Menu 52
 - 5.3. Increase Log Buffer Maximum Size 53
 - 6. SLSS CANData Viewer 54
 - 6.1. SLSS CANData Viewer Main Program 55
 - 6.2. Import ASC log files 56
 - 6.3. Loading the Database file and enhancing the logged data (DBC, LDF) 57

6.4. Converting imported .XMT files into SLSS CANAnalyser .CASF or .CSSF files	58
6.5. Playback Graphical Analyser from the Data Viewer	59
7. TCP/IP Communication Interface for Third-party applications	60
8. Hardware Dongle Firmware Updater	61
9. Troubleshooting	63
9.1. PC System resources	63
9.2. Wiring and Hardware setup	63
9.3. Dongle Hardware Configuration	64
9.4. Bit Rate Switch (BRS) Issues	65
9.5. Diagnosing Specific Issues	66
10. Appendix / References	66

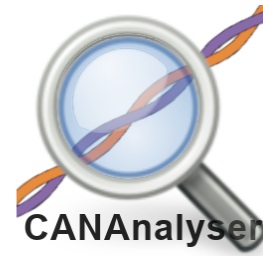

Users Manual

Based on software version 1.2.4.1L

The information contained in this Publication is Proprietary to SeRoSys Technology LLC and Sebastian Langer Software Solutions UG (haftungsbeschränkt)



1. Getting started





You must use a USB2.0 compatible cable with the CANAnalyser dongles, not a charge-only USB cable.

1.1. Hardware

For compatibility to the Pro version of SLSS CANAnalyser, please purchase one of our hardware variants. The latest list of variants can be found online here: <https://serosys-tech.com/product-lineup/>

Table 1. Supported Hardware Options

Hardware Model	Basic Feature Information
<p>Desk CAN Pro</p> 	<p>The starting point professional CAN hardware module with more features and power</p> <p>Competitive high speed CAN bus traffic support and full dual CAN bus monitoring plus male and female DB9 ports for CAN traffic pass-through bus tapping, Stand-Alone sending, macro message sending, TCP/IP and API interface and much more out of the box!</p>
<p>Storage CAN</p> 	<p>Advanced Features and data storage hardware module with peripheral interface for a customized experience</p> <p>Desk CAN Pro plus a micro-SD reader and the ability to be powered externally via DB9 for standalone datalogging. In addition, peripheral interface through the qwiic I2C bus interface.</p>
<p>Lab CAN</p> 	<p>Tailored for a more integrated hardware programmable lab environment</p> <p>Storage CAN with upgraded support for GPIO interface with 2 inputs and 2 outputs, gateway function and CAN bus playback.</p>

1.2. Connector Pinouts

1.2.1. DB9 (D-sub9) Connector

The pinout is the same for both Male and Female connectors. They are internally connected pin to pin and will pass through bus traffic even if unpowered.

Pin #	Function
1	No Connection
2	CAN bus CH-A Low
3	Ground
4	CAN bus CH-B Low
5	No Connection
6	Ground
7	CAN bus CH-A High
8	CAN bus CH-B High
9	12V B+ (only on Lab CAN and Storage CAN. All other variants this is N/C)

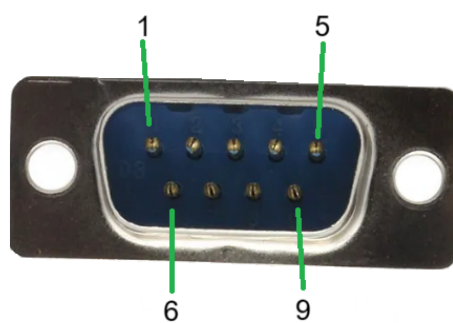
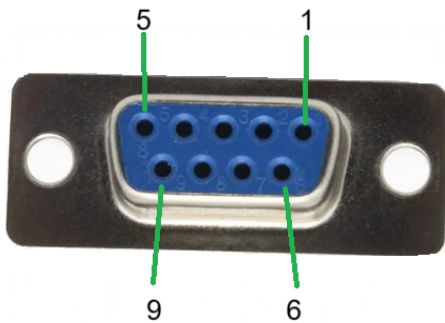
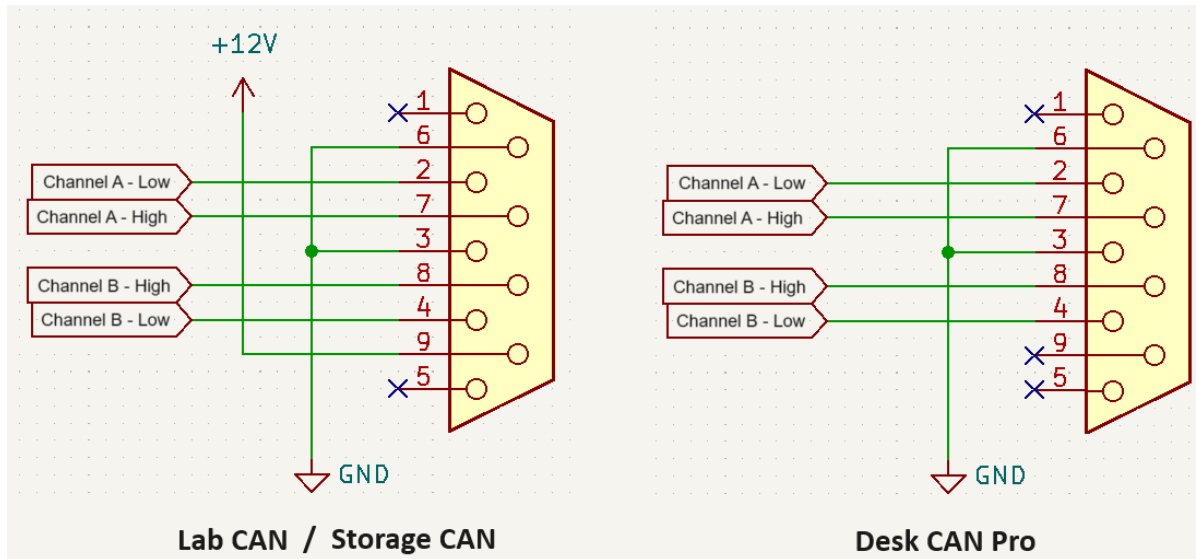

Power

- Only available on Lab CAN and Storage CAN
- Input power voltage supply range: +7 V to +28 VDC (nominal \approx 12 VDC)
- Reverse voltage and transient voltage protection

Ground

- Ground pins are all connected internally

CAN Bus High / Low

- Even though the differential CAN Bus high and low pins do not require a ground reference, it is recommended that ground is carried with these pins for common-mode voltage rejection to avoid potential damage to the transceivers

1.2.2. GPIO Connector

Applicable to Lab CAN only



GPIO pins 1 and 2 are inputs

GPIO pins 3 and 4 are outputs



These pins require a ground reference to be connected between the external device and the dongle. The ground reference can be acquired from pins 3 or 6 on either of the DB9 (D-sub9) connectors.

Electrical Parameters

- Automotive grade I/O
- At overtemperature the regulator on the GPIO inputs is automatically turned off by the integrated thermal protection circuit
- 4 GPIO pins supported (2 input, 2 output)
- Output pins for sending CAN signals on GPIO triggers Input pins to trigger a GPIO based on a CAN input received

- Short Circuit Protection on all GPIO pins
- GPIO inputs protected from -43VDC to 45VDC
- GPIO outputs provide up to 100mA steady state at CMOS logic levels (0V / 5V)
- GPIO outputs support input overvoltage protection to 28VDC

Mating Connector

Pluggable System Terminal Block. There are many suppliers of this style of connector. This is one example:

Phoenix Contact 1840382
 LCSC Part # C480547
 Package - Pitch = 3.5mm

<https://www.phoenixcontact.com/en-us/products/pcb-plug-mc-15-4-st-35-1840382>



MC 1,5/ 4-ST-3,5 - PCB connector

1840382

PCB connector, nominal cross section: 1.5 mm², color: green, nominal current: 8 A, rated voltage (III/2): 160 V, contact surface: Tin, contact connection type: Socket, number of potentials: 4, number of rows: 1, number of positions: 4, number of connections: 4, product range: MC 1,5/...-ST, pitch: 3.5 mm, connection method: Screw connection with tension sleeve, screw head form: L Slotted, conductor/PCB connection direction: 0 °, plug-in system: COMBICON MC 1,5, locking: without, mounting: without, type of packaging: packed in cardboard

1.2.3. USB Connector

Under normal operating conditions while connected to the SLSS CANAnalyser software, the USB power is provided by the USB port of the PC it is connected to.

Under the mode of operation in the StandAlone sending mode, if the dongle is powered by a USB connection that is not connected to a PC, the USB supplied current must be a minimum of 250mA for proper operation of the CAN bus line outputs.

1.2.4. qwiic Connector

Many of our dongles support the Sparkfun qwiic interface. This is a standardized interface created by Sparkfun. Please refer to their page for all the technical details and pinout information as maintained by their company.

<https://www.sparkfun.com/qwiic>



2. SLSS CANAnalyser Software



If desired to use more than 1 dongle on the same PC, please note that multiple instances of the CANAnalyser software may be run at once! So if you want to connect 2 dongles, you can run an additional instance of the software.



To ensure all buttons are accessible and all information is visible, a recommended resolution of 1920 x 1080 at 125% scale is suggested. Scale settings over 150% are not supported



Your PC should have a minimum of 8GB of RAM and keep system resources low for optimal performance.

2.1. The Main Screen Layout

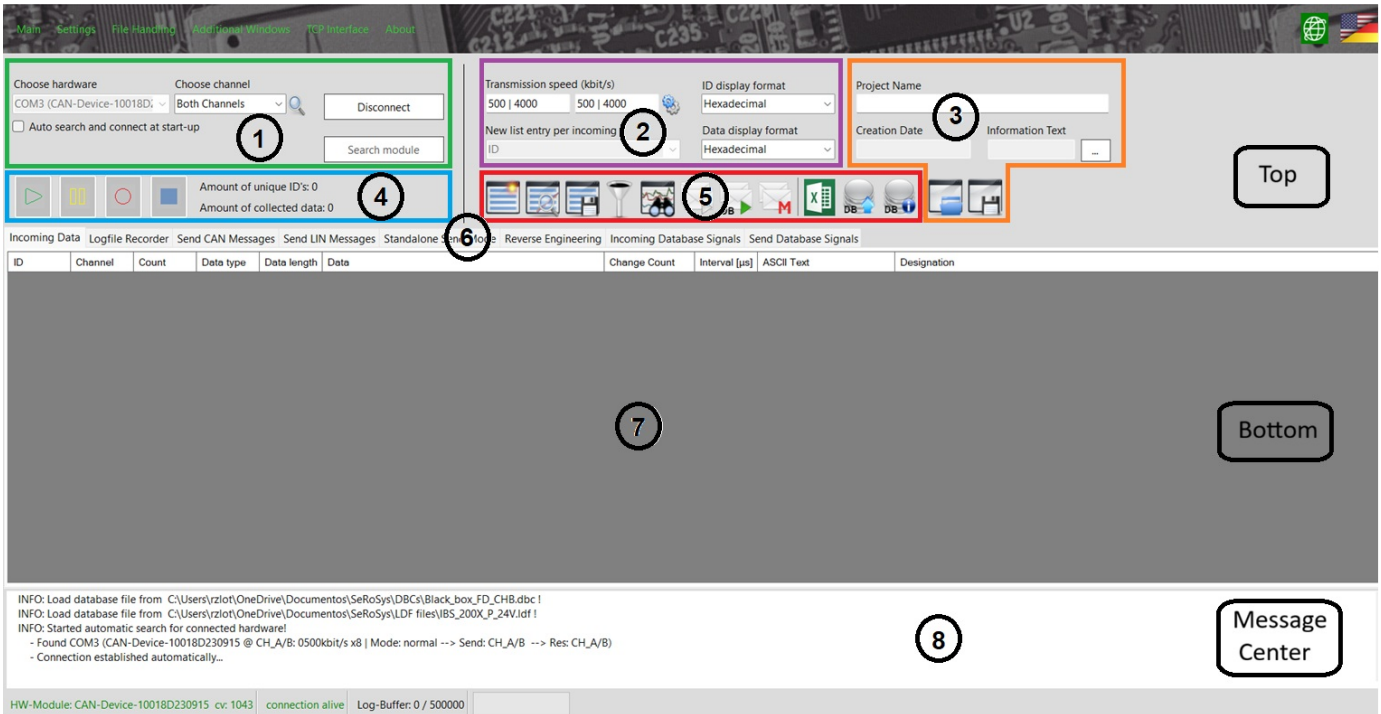

The screen is broken into 3 main vertical regions: Top, Bottom and Message Center.

The Top area contains all the common functions that transpose into the bottom feature tabs and will be context adjusting based on which feature tab is open in the bottom. You will always have all the required controls within reach that are agnostic of which feature tab is open.

The Bottom area shows the CAN traffic or gives you access to the various functions within each feature tab.

The Message Center area shows general log information and other important information.

Here is a description of each of the numbered zones on the main screen:

1. This is the area where all the module hardware physical connection options are made
2. This area controls the CAN connection speed and channel modes and lets you choose the format you want to see and record all data
3. The place to record information about your project that you desire to save notes and give titles and information for future reference. By default, a directory will be created and used under **Documents\SLSS CANAnalyser Projectspace**
4. Allows the user quick button access for recording / playing / pausing CAN data in the Incoming/Logging tabs and shows traffic data highlights
5. These buttons are unique and context specific in most cases to the currently selected feature tab, as well as fixed buttons for the database control and sending plus access to the visual graphical analyser and message filters and offers global access to send / stop sending CAN messages from any mode as well as entering Macro sending mode. See section "Contextual Buttons and Features"
6. This is where to select the desired feature tab
7. This is the Bottom area where all relevant information is displayed related to the selected feature tab
8. This is the Message Center area which shows information such as the connection status, hardware module information and connection speed and message buffer usage.
9. The software should install and start in English by default, however if a user desires to change the operating language to German, simply left-click on the flags to alternate between English and German language.



If the connection status (Connection Alive message in the bottom of the screen) is red then your PC has low resources. Please close other applications for improved performance.

2.2. Message Center Details

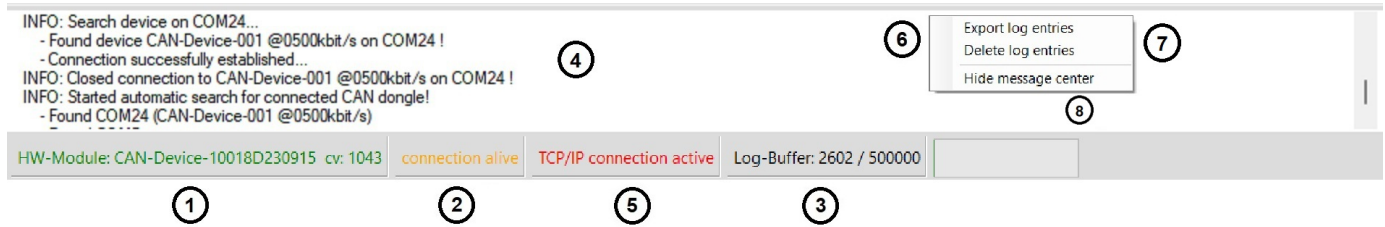

1. Hardware module connection information (once connected properly). Otherwise it states that there is no module connected.
2. Displays connection quality (if connected). (Green color / Yellow color / Red color) If Yellow and Red colors are blinking then consider closing other programs to free up system resources.
3. Shows the current log buffer size used and the maximum size. To increase the log buffer size, see section "Increase Log Buffer Maximum Size"
4. Logged Data from the SLSS CANAnalyser. This may be scrolled through (scroll-bar on the right) to view important chronologically listed SW log data
5. Informs the user that the TCP/IP port has been enabled for incoming connections

Right click menu activates these options inside the Message Center:

6. Button to export the SLSS CANAnalyser log data
7. Button to clear out the SLSS CANAnalyser log data
8. Hides this entire lower message center (it can be re-enabled from the Settings menu)

To reenale the Message Center:

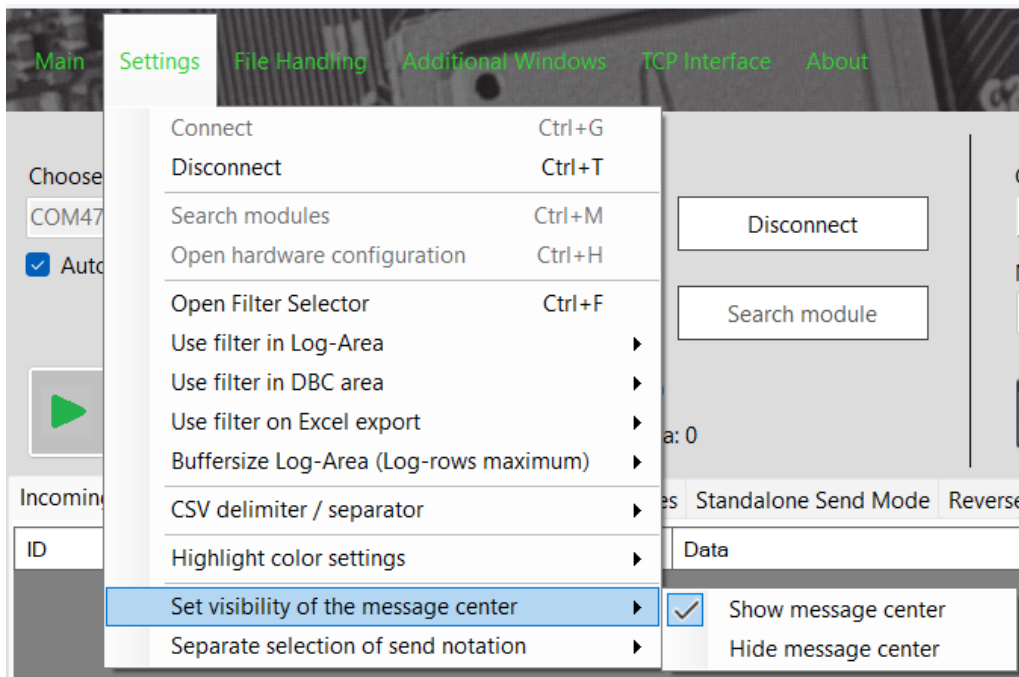

2.3. Understanding the LEDs on the CAN Dongles

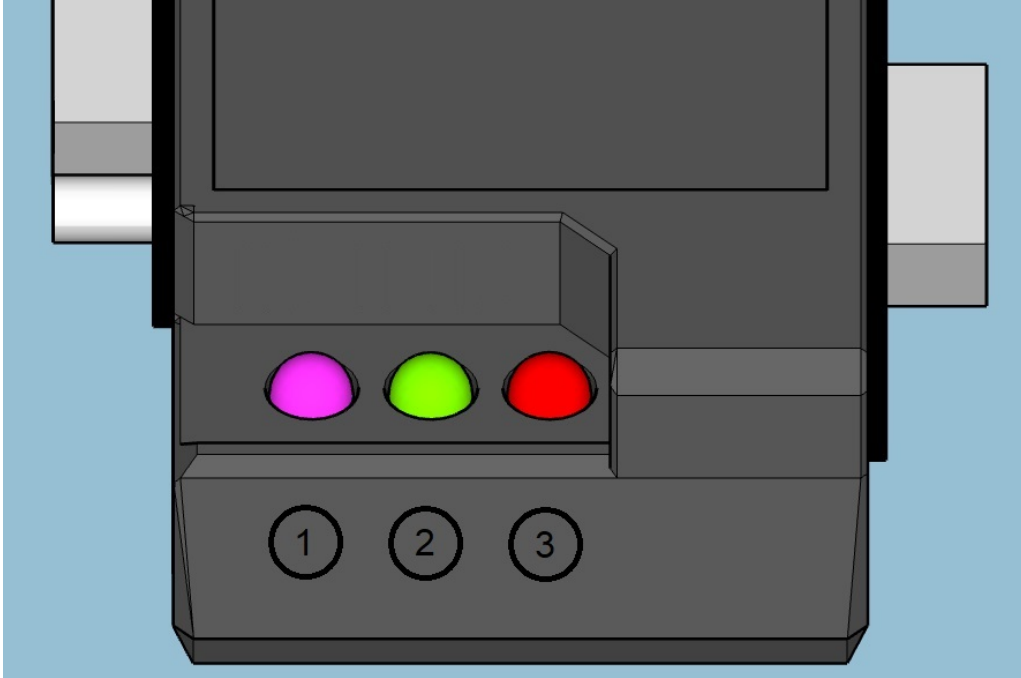

2.3.1. Standard Mode while connected to SLSS CANAnalyser

1. LED 1 - Power and Connection - **Solid Red** - Hardware module is powered up. - **Blinking purple** - Hardware module has an active live connection to the software.
2. LED 2 - CAN bus CH-B - **Green** - Incoming CAN traffic received. - **Red** - Outgoing CAN traffic is being sent. - **Amber** - Incoming and Outgoing traffic
3. LED 3 - CAN bus CH-A - **Green** - Incoming CAN traffic received. - **Red** - Outgoing CAN traffic is being sent. - **Amber** - Incoming and Outgoing traffic

2.3.2. StandAlone Mode while disconnected from SLSS CANAnalyser

1. LED 1 - While a sent message list is stored on the dongle, this LED is always **Blinking purple** - Note that the blinking speed is slower in this mode to indicate it is in Standalone Mode
2. LED 2 - CAN bus CH-B - **Red** - Outgoing CAN traffic is being sent. - **Amber** - Error state indicator for sending CAN messages
3. LED 3 - CAN bus CH-A - **Red** - Outgoing CAN traffic is being sent. - **Amber** - Error state indicator for sending CAN messages

2.4. Establishing the Connection Between Software and CAN Dongle

2.4.1. Connecting to the Dongle Hardware

There are a few ways of connecting the hardware module to the software.

Please make sure you are using a USB 2.0 data cable and that the **Solid Red** color LED is lit up before trying to connect.

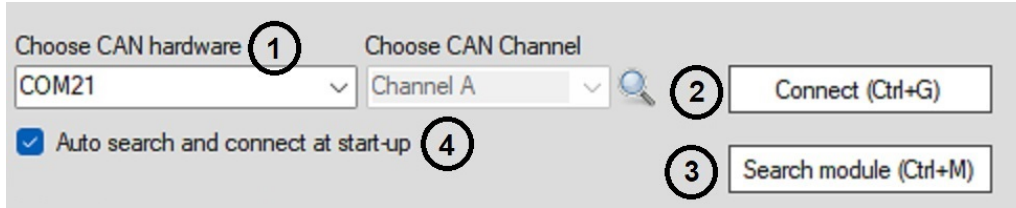

Manually selecting a COM port and then connecting

1. Select the COM port for your hardware dongle in the drop-down box
2. Select the Connect button

This will tell the software to look for the hardware dongle on that port. If it finds the hardware and connects to it, the hardware connection LED will begin blinking purple. If it does not find it, please select a different port and ensure the proper USB driver has been installed.

Automatically searching for your hardware dongle after the program has already been loaded

3. Select the Search Module button and let the software automatically search through the available COM ports to find your hardware dongle. If it finds the hardware and connects to it, the hardware connection LED will begin blinking purple. If it does not find it, ensure the proper USB driver has been installed.



Automatically searching for the dongle may take up to 10 seconds. Direct connect is always faster by selecting the COM port from the drop-down.

Automatically searching for your hardware dongle upon loading the software

4. If desired, the check-box next to "Auto search and connect at start-up" may be selected. Once selected, the next time the software is loaded, it will automatically search for the hardware dongle upon start-up. If it finds the hardware and connects to it, the hardware connection LED will begin blinking purple. If it does not find it, ensure the proper USB driver has been installed.



Automatically searching for the dongle may take up to 10 seconds. Direct connect is always faster by selecting the COM port from the drop-down.

2.4.2. Connection Speed, Connection Mode and List Entry Style

CAN speed (kbit/s) ① 500 | 4000 500 | 4000 CAN ID display format Hexadecimal

New list entry per incoming ② ID CAN Data display format Hexadecimal



500 kbit/s is the default standard used in most automotive applications so it is our factory default connection speed.

1. Shows the Connection Speed for each channel. The speed and mode can be changed from here
2. Select the option from drop-down menu to view Incoming Messages either by unique ID's or by pure scrolling messages
 - ID - Only 1 unique ID row is shown in all the data available in the Incoming CAN data tab and just the data changes
 - Data - Every message with changing data will be shown sequentially in a unique row, even if it is the same ID

2.4.3. Set the Connection Speed and Connection Mode for each Independent Channel

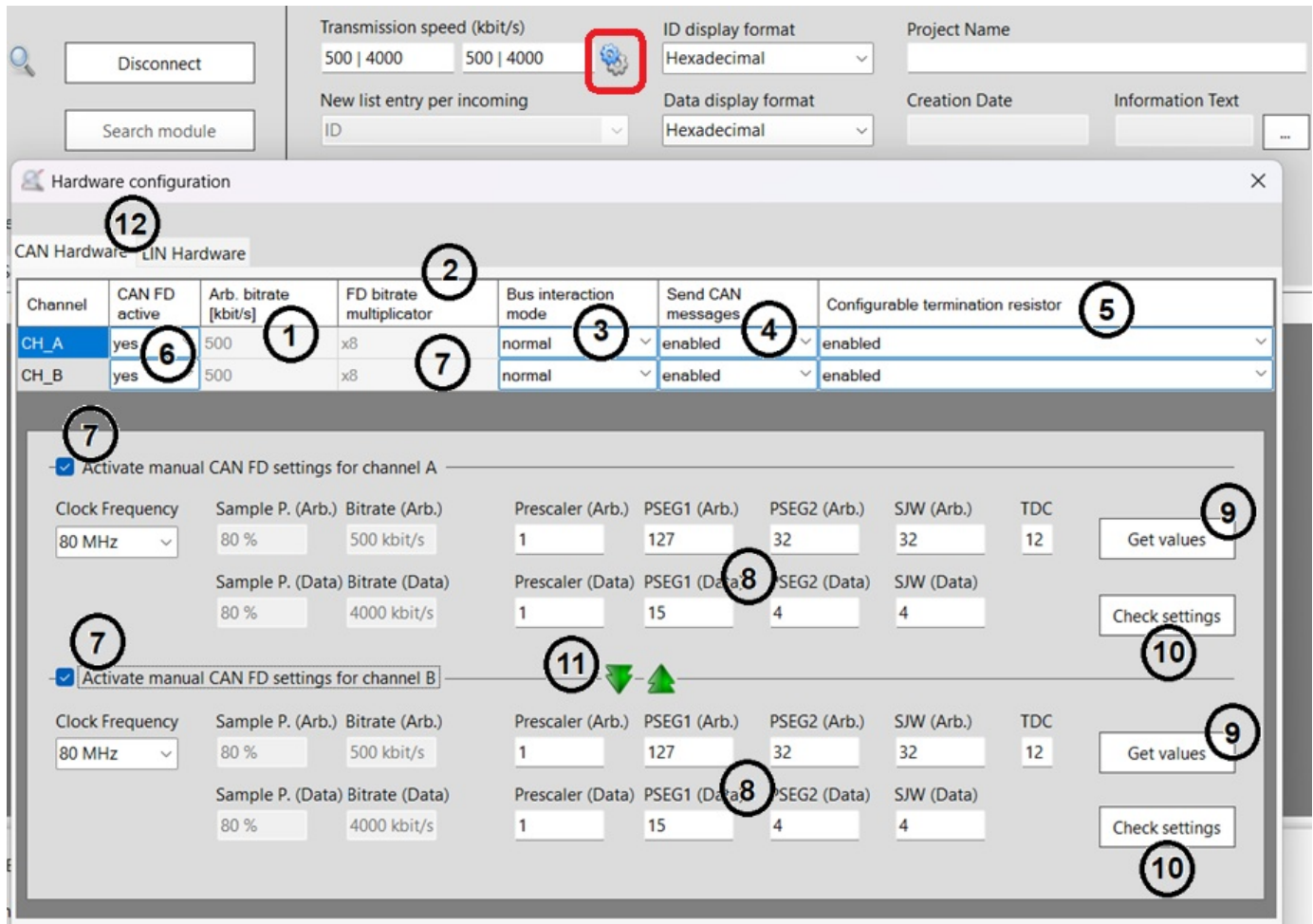

Press the image of the gears to open the Hardware Configuration window. The Connection Speed and Connection Mode for each channel can be adjusted here.



Settings menu is only accessible when the dongle is disconnected. Make the desired changes and then reconnect.

1. Select the desired Arbitration bitrate from the drop-down menu. They are able to be independently set for each channel.
2. For standard ISO CAN FD setup, select the FD bitrate multiplier. They are able to be independently set for each channel.



If the manual CAN FD settings are activated below, this box will be greyed out and not used in the speed calculations.

3. Select the desired bus interaction mode from the drop-down menu. It lets you choose between normal mode (*Allows full send and receive interaction on the bus*), Listen Only mode (*Only able to receive bus messages but not able to send*), or Off (*Channel is completely shut off, no receiving or*

sending possible).



In Listen Only mode, if the dongle is connected to a bus that has a single node only, the Incoming data will show a very fast message count. This is because it is not an active multi-node bus. Once there are at least 2 nodes on the bus plus the dongle, it will operate normally. Also, the software will allow the Sending tab to appear as if it is sending messages, however they will not be sent to the actual bus



When selecting "Listen-only", the CAN speed will be indicated in red color. When selecting "off", the CAN speed will be indicated in grey color.

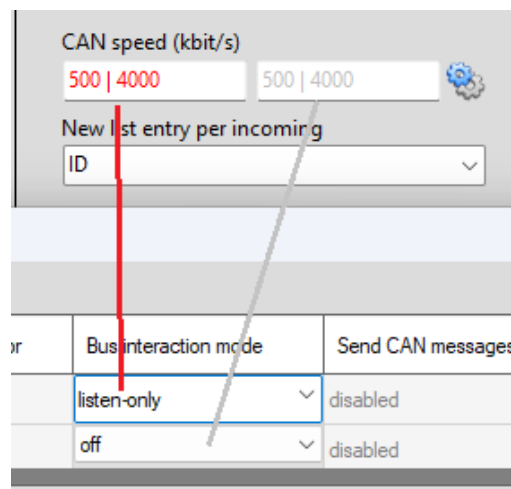

4. Choose to enable or disable message sending from the drop-down menu. This allows the user to lock out or enable each CAN channel from being able to send messages or not. If these are disabled, the Send CAN Messages Tab will not be functional
5. The drop-down menu allows a SW configurable option for enabling or disabling the 120 ohm bus terminating resistor (independently per channel)
6. CAN FD can be enabled or disabled from the drop-down
7. When selecting the checkbox to activate the manual CAN FD settings, the FD bitrate multiplier box greys out as this overrides it



For CAN FD, settings can be very critical and sensitive. This will help to provide many options from generic settings to very custom settings to customize the connection flexibility.

8. The values of all the critical CAN FD connection parameters may be manually set here. It is recommended to consult with a CAN FD bitrate calculator for best results
9. Selecting the **Get Values** button will open up a window to do the value calculations automatically based on a few user selectable inputs. The user will select the desired clock frequency, sample

points (Arb / Data), the desired Arbitration bitrate speed and the FD bitrate multiplier and the values will all be generated. Select **Apply settings** to set them

Retrieve CAN configuration parameters

Set the required CAN values

Clock Frequency: 80 MHz
 Sample Points (%): 80 | 75
 Bitrate (Arbitration): 500 kbit/s
 FD bitrate multiplier: x8

Prescaler	1 1	Data Bitrate	4000 kbit/s
Sample Point (Arbitration)	80	Sample Point (Data)	75
PSEG1 (Arbitration)	127	PSEG1 (Data)	14
PSEG2 (Arbitration)	32	PSEG2 (Data)	5
SJW (Arbitration)	32	SJW (Data)	5

Apply settings Cancel

10. Selecting the **Check settings** button will conduct a check of the values that are entered to ensure a valid matching set of calculations will work. This way you can easily check if the chosen settings are valid or not (as shown in these 3 following examples).

Results of the CAN settings check

CAN channel	Channel A	Clock Frequency	40 MHz
Arbitration Sample Point	80 %	Data Sample Point	80 %
Arbitration Bitrate	500 kbit/s	Data Bitrate	2000 kbit/s

Exact Arb. Bitrate Check	PASSED
Exact Data Bitrate Check	PASSED
Data Consistency Check	PASSED

Close

Results of the CAN settings check			
CAN channel	Channel A	Clock Frequency	40 MHz
Arbitration Sample Point	80 %	Data Sample Point	84 %
Arbitration Bitrate	500 kbit/s	Data Bitrate	2105 kbit/s
Exact Arb. Bitrate Check	PASSED		
Exact Data Bitrate Check	FAILED		
Data Consistency Check	PASSED		
Close			

Results of the CAN settings check			
CAN channel	Channel A	Clock Frequency	40 MHz
Arbitration Sample Point	80 %	Data Sample Point	84 %
Arbitration Bitrate	500 kbit/s	Data Bitrate	2105 kbit/s
Exact Arb. Bitrate Check	PASSED		
Exact Data Bitrate Check	FAILED		
Data Consistency Check	FAILED		
Close			

11. Select the arrow direction to copy the settings from either Channel A to Channel B, or from Channel B to Channel A.

12. Hardware variant tabs (CAN, LIN, qwiic/I2C)

2.5. Selecting Your Desired CAN Bus to Monitor

To change between CAN bus monitoring and sending between the CAN channels supported by your hardware.

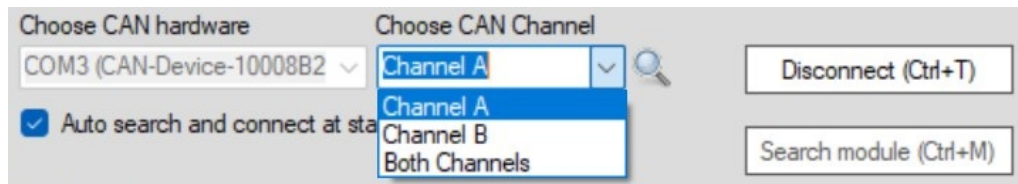

1. Select the drop-down to choose your CAN channel. Once selected, the software will showing incoming traffic and send outgoing traffic on the specified channel(s).



If the drop-down menu is greyed out or you cannot select Channel B, the license file does not match the hardware dongle connected to it!

2.6. Controlling the Recording / Displaying of CAN Traffic

The buttons allow control over the data recording and display as well as the showing the summary of ID's and amount of data collected

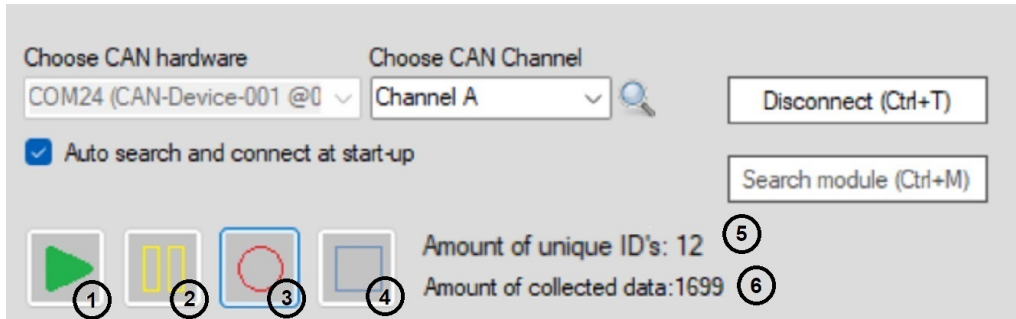

1. The **Play** button is activated by default to show all incoming CAN message data
2. The **Pause** button is used to pause the display and recording of CAN message data
3. The **Record** button is used to record the CAN message data in the buffer
4. The **Stop** button is used to stop the display and recording of CAN message data



Keyboard shortcut for Play, Pause, Record and Stop are F5, F6, F7, F8



If a database file is loaded, a context box will ask if the user desires to enhance the log files. This will take some time to post-process and add all of the database human readable signal data to the logfile and will be available in the exports. See the section **Incoming Database Signals Feature Tab** for more details.

5. This displays the number of unique CAN arbitration ID's seen on the incoming data bus (regardless of which channel it is on)
6. This displays the total quantity of messages received (for all channels)

2.7. Selecting the Global Data format to view CAN ID and CAN Data

These 2 drop-down menus allow the user to select their preferred data format used throughout all feature tabs and data exports.

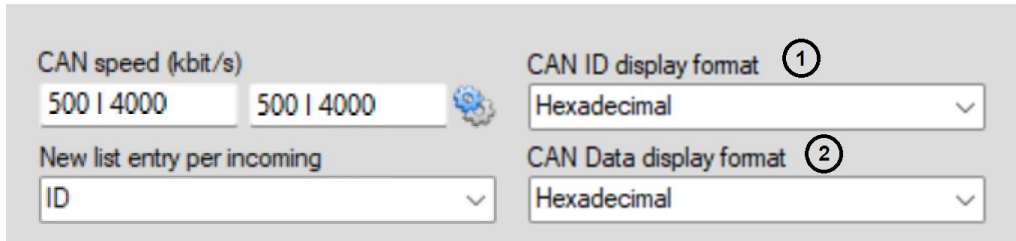

1. For Arbitration ID (CAN ID), choose between Hexadecimal, Decimal or Binary format
2. For CAN data, choose between Hexadecimal, Decimal or Binary format

3. Contextual Buttons and Features

These buttons offer some dynamic functionality. Depending on the selected analysis tab, some buttons dynamically change to fulfill the associated application purpose while others maintain functionality specific to the current analysis tab



Row A. These buttons are available in the following Feature tabs: "Incoming CAN Data" and "CAN Logfile Recorder"

Row B. These buttons are available in the following Feature tabs: "Send CAN Messages", "Standalone Send Mode", "Send Database Signals" and "Reverse Engineering"

Row C. These buttons are available in the following Feature tabs: "Incoming Database Signals"

Within each row, this is what each button does:

#	Row A	Row B	Row C
1.	Clears the current message list of all data and begins a fresh data view	Clears the current list of messages to be sent	This button is not available
2.	Loads a previously saved list of CAN data and opens it in a separate CAN data viewer window	Loads a list of previously saved data such as CAN messages or reverse engineering data	This button is not available
3.	Saves all currently displayed data from the currently active tab in a variety of format options	Saves all currently displayed data / configuration	This button is not available
4.	Opens the message filtering setup in a separate window	Opens the message filtering setup in a separate window	This button is not available
5.	Opens the Graphical Analyser Viewer in a separate window	Opens the Graphical Analyser Viewer in a separate window	Opens the Graphical Analyser Viewer in a separate window
6.	Starts or Stops messages in the active Send list from any mode	Starts or Stops messages in the active Send list from any mode	Starts or Stops messages in the active Send list from any mode
7.	Starts or Stops database Signal messages in the active Send list from any mode	Starts or Stops database Signal messages in the active Send list from any mode	Starts or Stops database Signal messages in the active Send list from any mode
8.	Enters Macro sending mode on the bottom of the screen (replacing the message center) This can be toggled on / off at any time	Enters Macro sending mode on the bottom of the screen (replacing the message center) This can be toggled on / off at any time	Enters Macro sending mode on the bottom of the screen (replacing the message center) This can be toggled on / off at any time
9.	Exports all data to Excel format (in multiple worksheet tabs)	Exports all data to Excel format (in multiple worksheet tabs)	Exports all data to Excel format (in multiple worksheet tabs)
10.	Opens a separate window with options to load a database file on Channel A or B independently as well as options to create / edit and save DBC files	Opens a separate window with options to load a database file on Channel A or B independently as well as options to create / edit and save DBC files	Opens a separate window with options to load a database file on Channel A or B independently as well as options to create / edit and save DBC files
11.	Opens a separate window to explore the details of loaded database messages and signals including search functionality	Opens a separate window to explore the details of loaded database messages and signals including search functionality	Opens a separate window to explore the details of loaded database messages and signals including search functionality

3.1. Exporting Logged Data

3.1.1. Excel Format

Upon pressing the Export button, an Explorer window will open to request the location and file name to save your Excel file.

Once the export is completed, this message will be displayed:

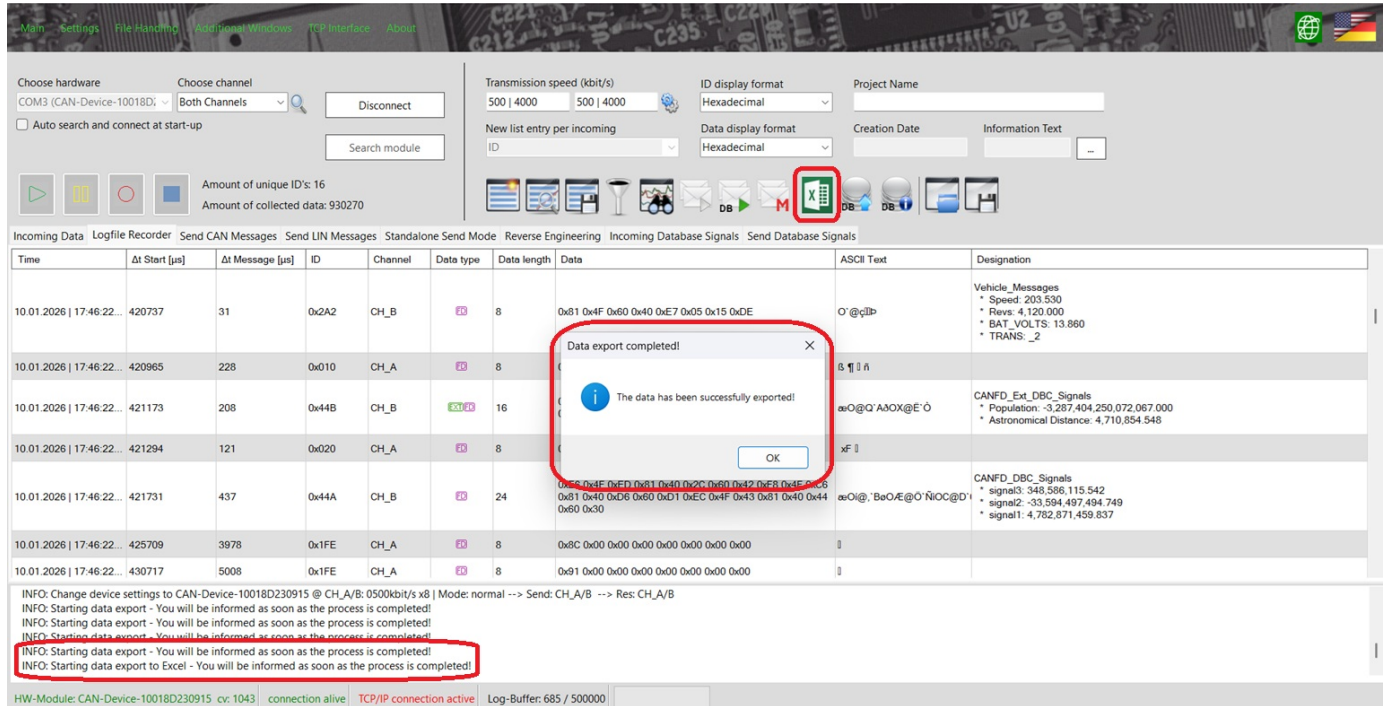

If you have a large amount of buffer data, the export may take a long time. If Excel export is chosen, the message center at the lower part of the screen informs the user that the export process has begun. The CANAnalyser software will continue normal operation until the export is completed and then a pop-up message will inform the user when the Export is complete. Avoid pressing the export button again before this process is completed to prevent it restarting the Export request. The CSV / ASC / TRC export is much faster!

3.1.2. CSV / TRC / ASC Formats

Unique to CSV only

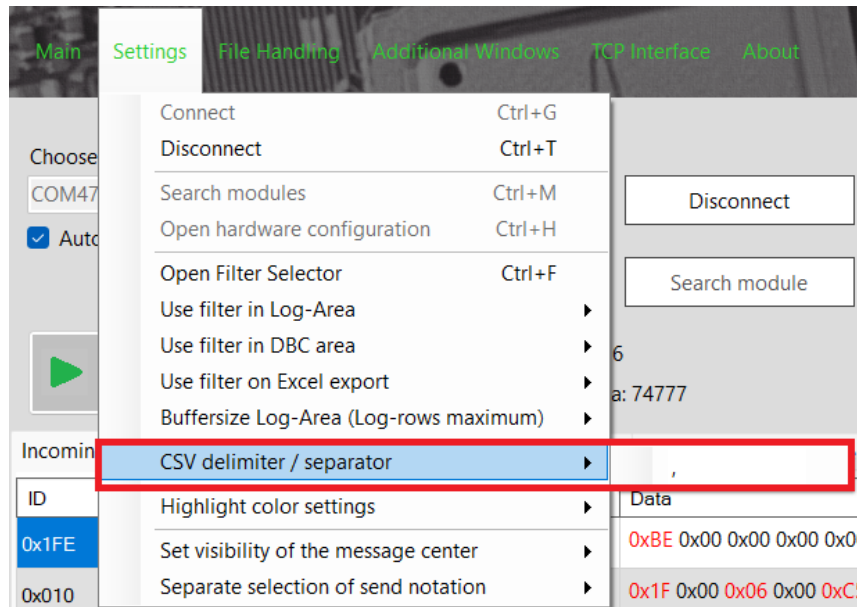

Since CAN data may contain ASCII characters that may conflict with a comma (standard default CSV delimiter), there is an option in the Settings dropdown to choose another delimiting character if desired.

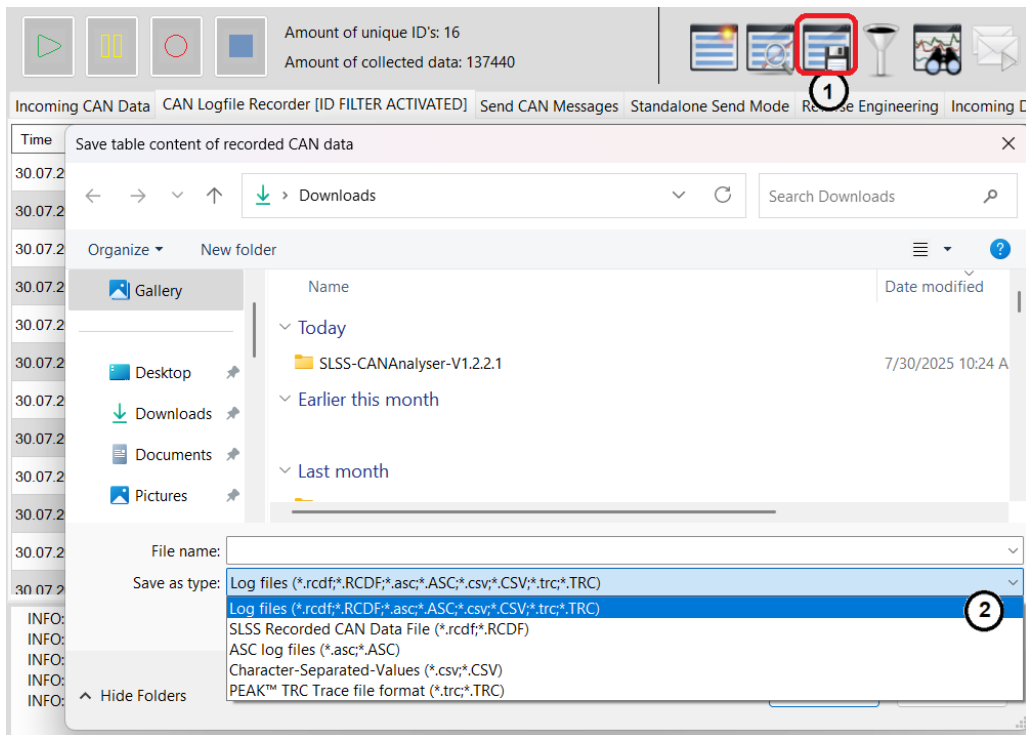

1. From the CAN Logfile Recorder Tab, press the Save button
2. From the drop-arrow, choose the desired CSV, TRC, ASC format and then provide the File Name and location to save

3.2. Message Filtering Button

This is a separate window that opens to be able to move to a separate screen or show as a separate window to be able to view the impact of adjusting filter settings on the fly in different feature tabs.

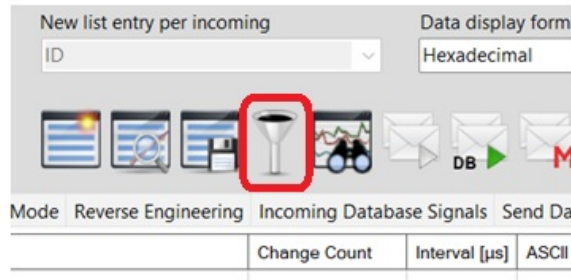

SLSS CANAnalyser CAN filter settings

9

Set / add filter range

Start ID 2 End ID 3 Show Hide

29bit ID (CAN2.0B)

Filter options

Hide new incoming and unfiltered ID's automatically

Include this filter in the Log-Area as well 7

Include this filter in the database area as well

4 Show / hide all listed ID's

ID (hexadecimal) 5	Visible 6	Designation 8
0x1FE	<input checked="" type="checkbox"/>	
0x010	<input checked="" type="checkbox"/>	
0x020	<input checked="" type="checkbox"/>	
0x12AAEAAB*	<input checked="" type="checkbox"/>	
0x1AB	<input checked="" type="checkbox"/>	
0x7AE	<input checked="" type="checkbox"/>	
0x7AF	<input checked="" type="checkbox"/>	
0x555	<input checked="" type="checkbox"/>	
0x0FD	<input checked="" type="checkbox"/>	
0x1FF	<input checked="" type="checkbox"/>	
0x404	<input checked="" type="checkbox"/>	
0x123	<input checked="" type="checkbox"/>	
0x2A2	<input checked="" type="checkbox"/>	Vehicle_Messages
0x44B*	<input checked="" type="checkbox"/>	CANFD_Ext_DBC_Signals
0x44A	<input checked="" type="checkbox"/>	CANFD_DBC_Signals
0x556	<input checked="" type="checkbox"/>	

vehicle 1

1. This is the textual search filter. All text entered here will be highlighted in the filter chart
2. Enter in a single CAN ID or a range (Start ID to End ID) to use as your filter criteria. Check the box for 29bit ID for filtering Extended IDs
3. After selecting your CAN ID or CAN ID range, select either **Show** or **Hide** to affect the checkboxes in the table below for visibility of the selected IDs
4. This button can be toggled to **Show** or **Hide** ALL visible ID's (checkboxes) in the table below
5. Lists all current received message ID's on the active bus
6. List of checkboxes to show which ID's will be shown or hidden
7. Checkbox options of where to apply the impact of the filter settings
8. If a database file is currently loaded, the human readable designations of the ID's will be shown here for reference
9. The filter settings may be saved and loaded for easier future access



It is possible to show both the Standard and Extended ID's in the same filter area. The * indicates an Extended ID

3.3. DB button

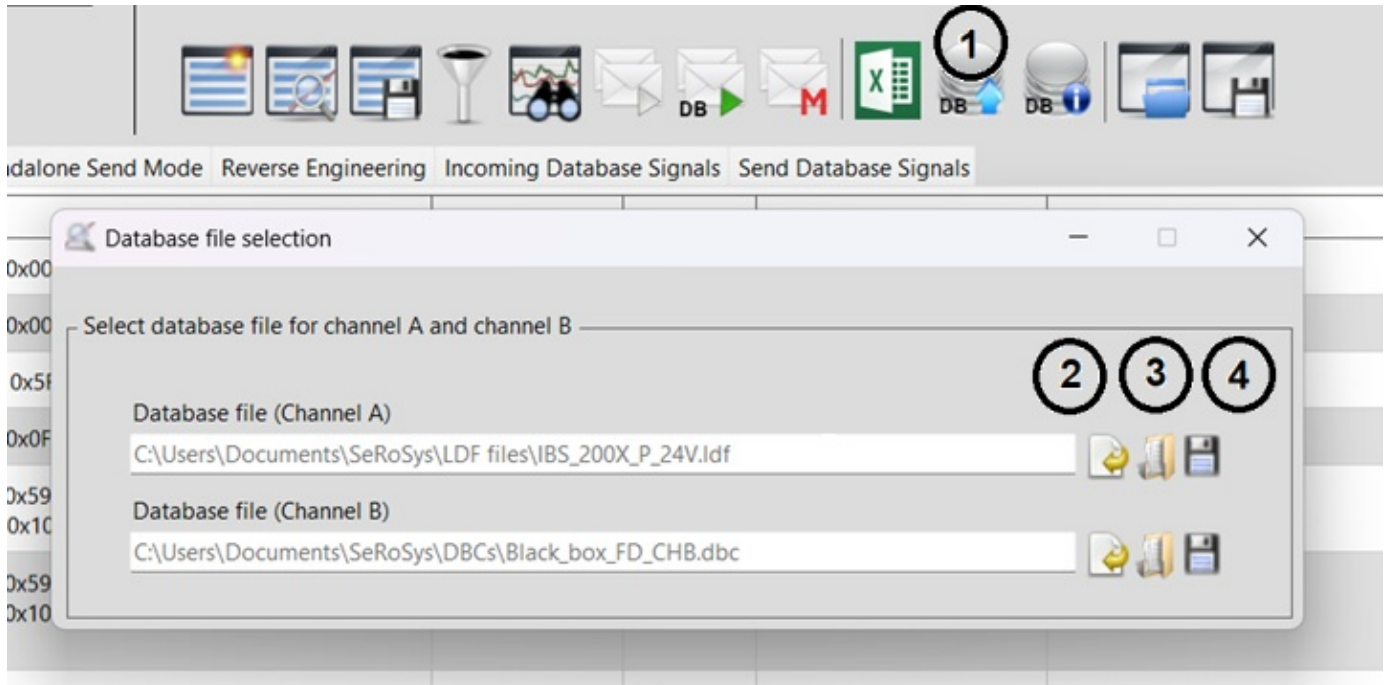

1. Press this button to open a dialog box to select a unique database file to load into each channel independently. Current supported database formats are DBC (CAN) and LDF (LIN)
2. This opens the database editor. See details on the editor in the next sub-section.



Only DBC files are supported currently in the editor

3. This is to open a valid database file
4. This will save your current active database file

3.3.1. DB Editor

The screenshot shows a software interface for creating and managing database signals. At the top is a dialog box titled "Create new database signal for channel B" with the subtitle "Define a new DBC signal". The dialog contains several input fields: "CAN ID* (decimal)", "Signal name* (max. 32 characters)", "Frame (bytes)", "Start bit*", "Number of bits*", and "Signal type (LSB -> MSB)" (set to "Intel"). There is also a checkbox for "29bit ID (CAN2.0B)" and an "ID designation* (max. 32 characters)" field. Below these are fields for "Sign*" (set to "without"), "Scaling*" (0), "Offset*" (0), "Minimum value" (0), "Maximum value" (0), and "Unit". A "Create signal" button is circled with a "1".

Below the dialog is a table listing existing signals. The "Edit" and "Delete" columns are circled with "2" and "3" respectively.

ID (decimal)	Signal name	Start bit	Number of bits	Scaling offset	Unit	Edit	Delete
674	Speed	0	16	0.01 0	Kph	edit	delete
674	Revs	16	16	.25 0	RPM	edit	delete
674	BAT_VOLTS	32	8	0.06 0	Volts	edit	delete
674	TRANS	63	2	1 0	POS	edit	delete
1099*	Population	64	64	0.001 1	People	edit	delete
1099*	Astronomical Distance	0	64	0.000000000001 0	Parsecs	edit	delete
1098	signal3	128	64	0.0000000001 0	Dimesion1	edit	delete
1098	signal2	64	64	0.00000001 0	Dimesion2	edit	delete
1098	signal1	0	64	0.000000001 0	Dimesion3	edit	delete
1122	Test_blank_signal	12	10	0 0	N/A	edit	delete

1. In this top box, all data to create a new signal may be input and then press the **Create signal** button to add it as an entry to the list (appending or a new list).
2. Pressing the **Edit** button will allow an existing signal to be edited.
3. Pressing the **delete** button will allow an existing signal to be deleted.

3.4. Database Explorer button (DBC, LDF)

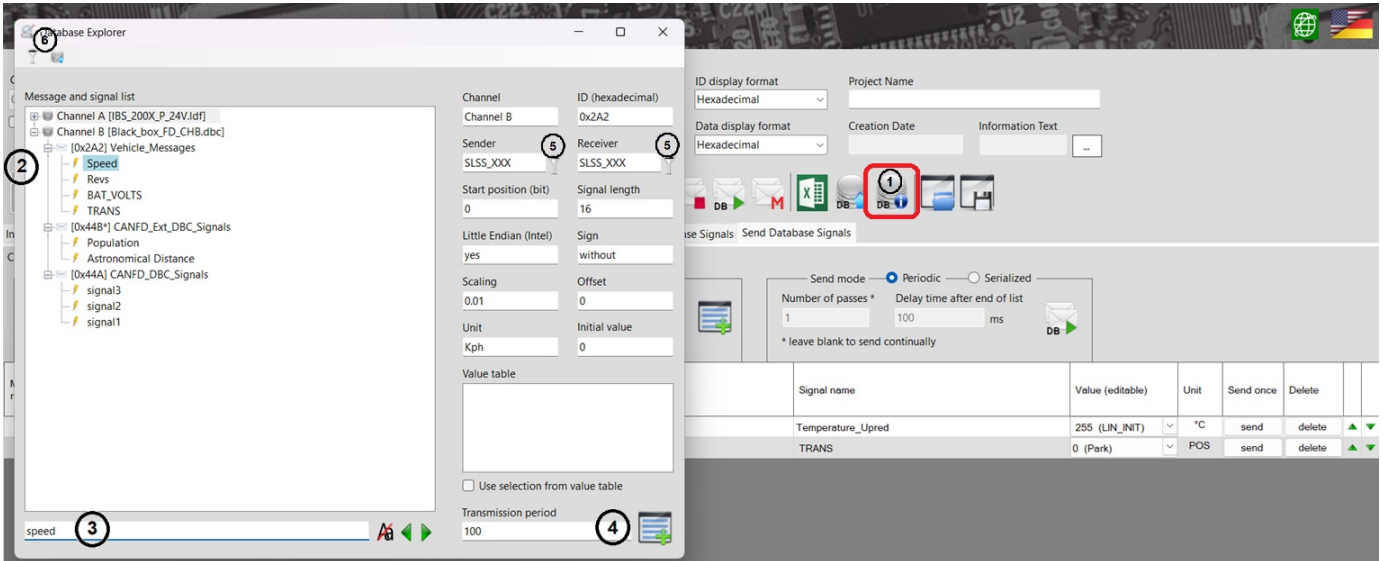

1. Press this button to open the Database Explorer window
2. All loaded databases on Channel A / Channel B will show (initially nested). Click the + / - buttons to expand or contract the tree of Message Signals
3. To quickly find the desired Signal, enter the Signal name in the textual search bar
4. The selected Signal may be directly add to the Send Database Signal tab of message to send. Specify the Transmission period and press the button to add it to the list
5. Selecting the filter icon next to the Sender or Receiver box opens a list of all the ECU's for filtering. See next sub-section for details
6. These 2 icons are shortcuts to the relevant Filter Settings and Database selection windows

3.4.1. Right-Click context menu

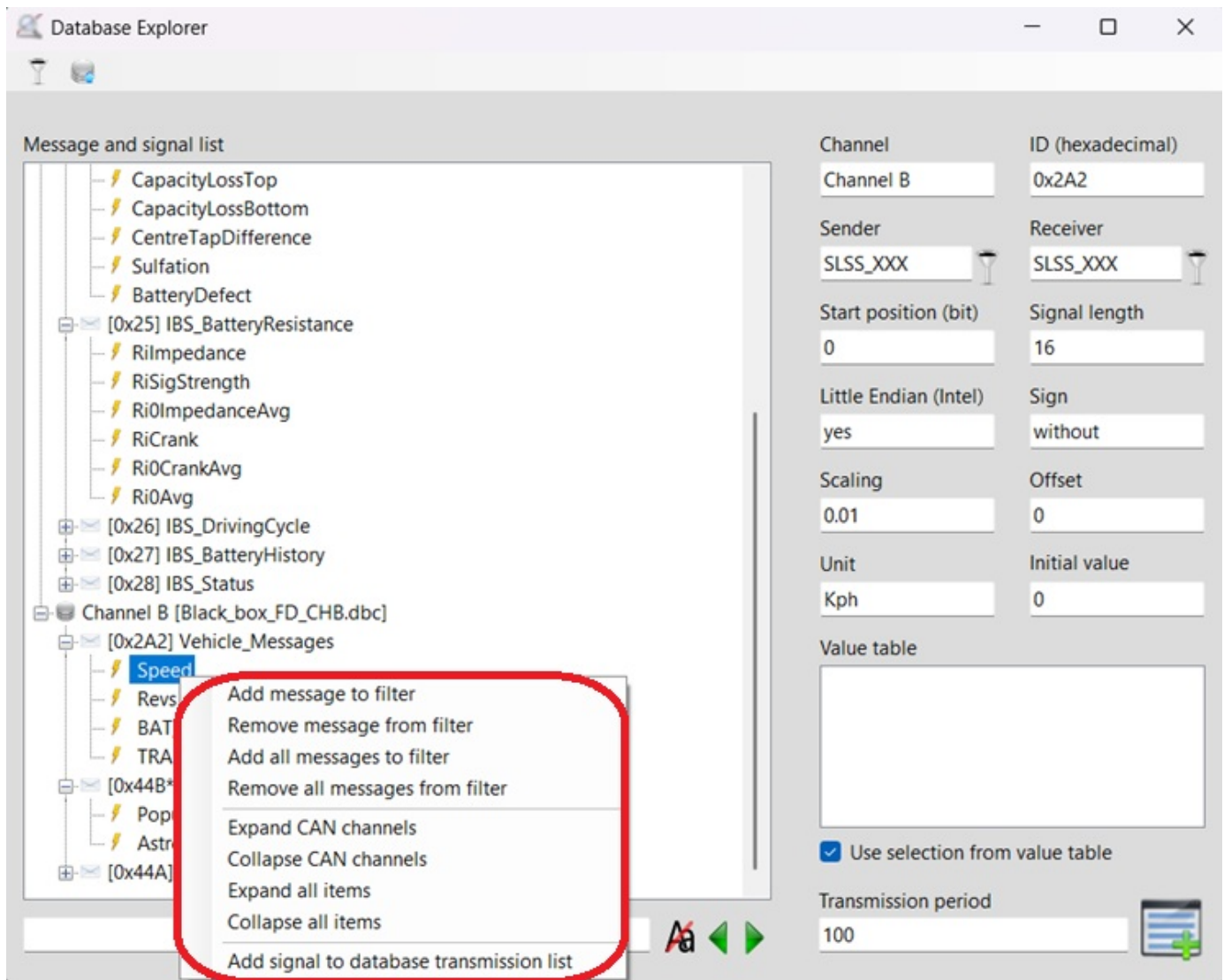

1. Right-Click on a Signal name to bring up powerful shortcut actions such as Filter impacts and adding the desired Signal to the Send Database Signals tab

3.4.2. ECU Filtering

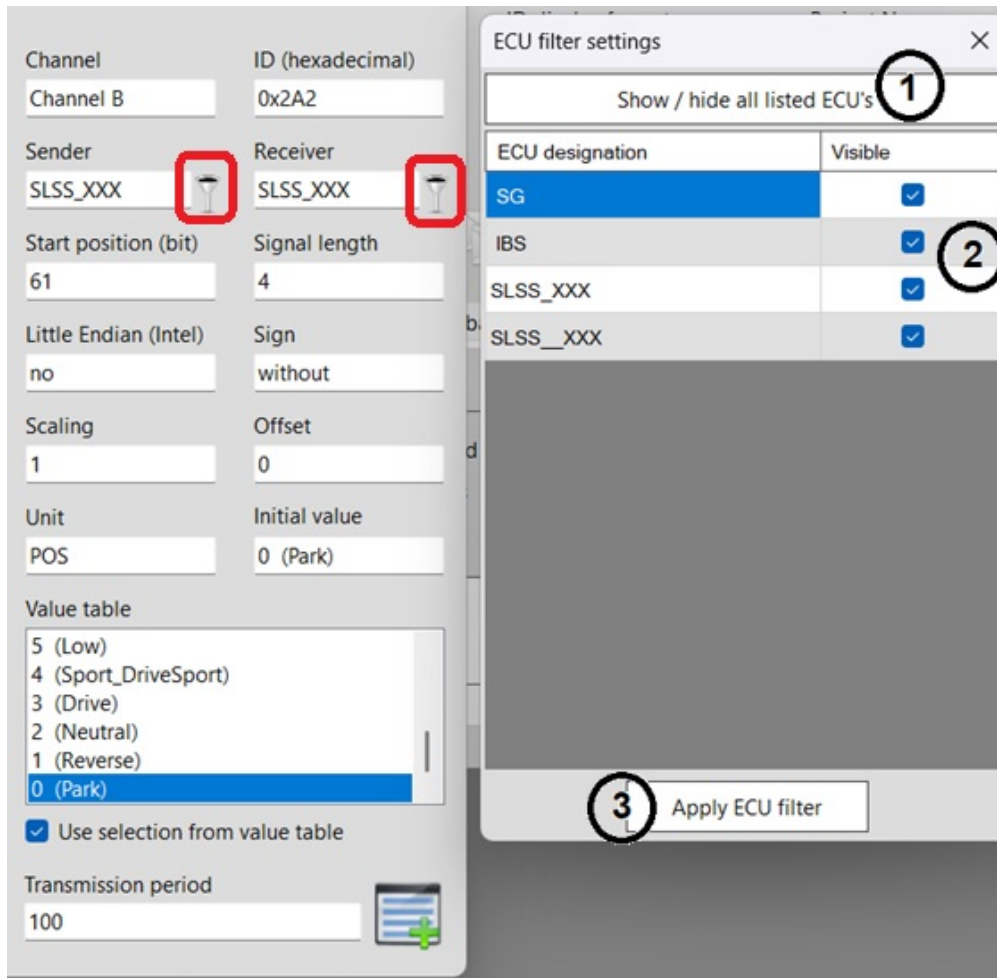

1. Press this to quickly show or hide all the checkboxes in the list below
2. Manually check or uncheck boxes to specify the target ECU's to filter in or out
3. Press this to apply the ECU filtering. This impacts the overall Filters from the Message Filtering button on the main screen. Impacted message ID's that share the ECU type will all be checked or unchecked on that filter window

3.5. Graphical Analyser Viewer Button

Often it is easier to visually represent data to make it user friendly for simpler data analysis. This adjustable graphical interface allows analysis of data bytes independently and the user can save the graph image / data for future use.

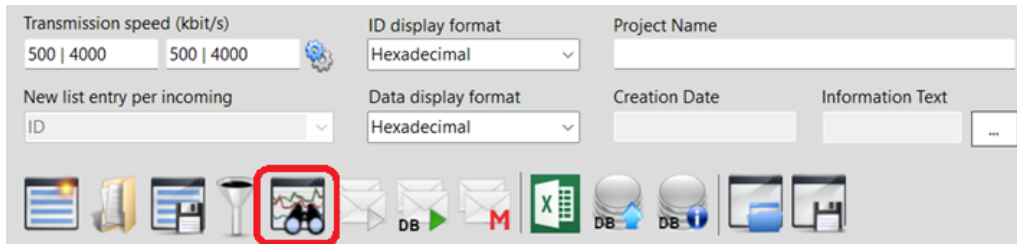

Multiple windows may be opened to view more than one graph. Right-click on a message in the Incoming CAN Data tab will allow a CAN ID to be directly brought up in the graph as well as clicking the contextual button in the top part of the main screen.

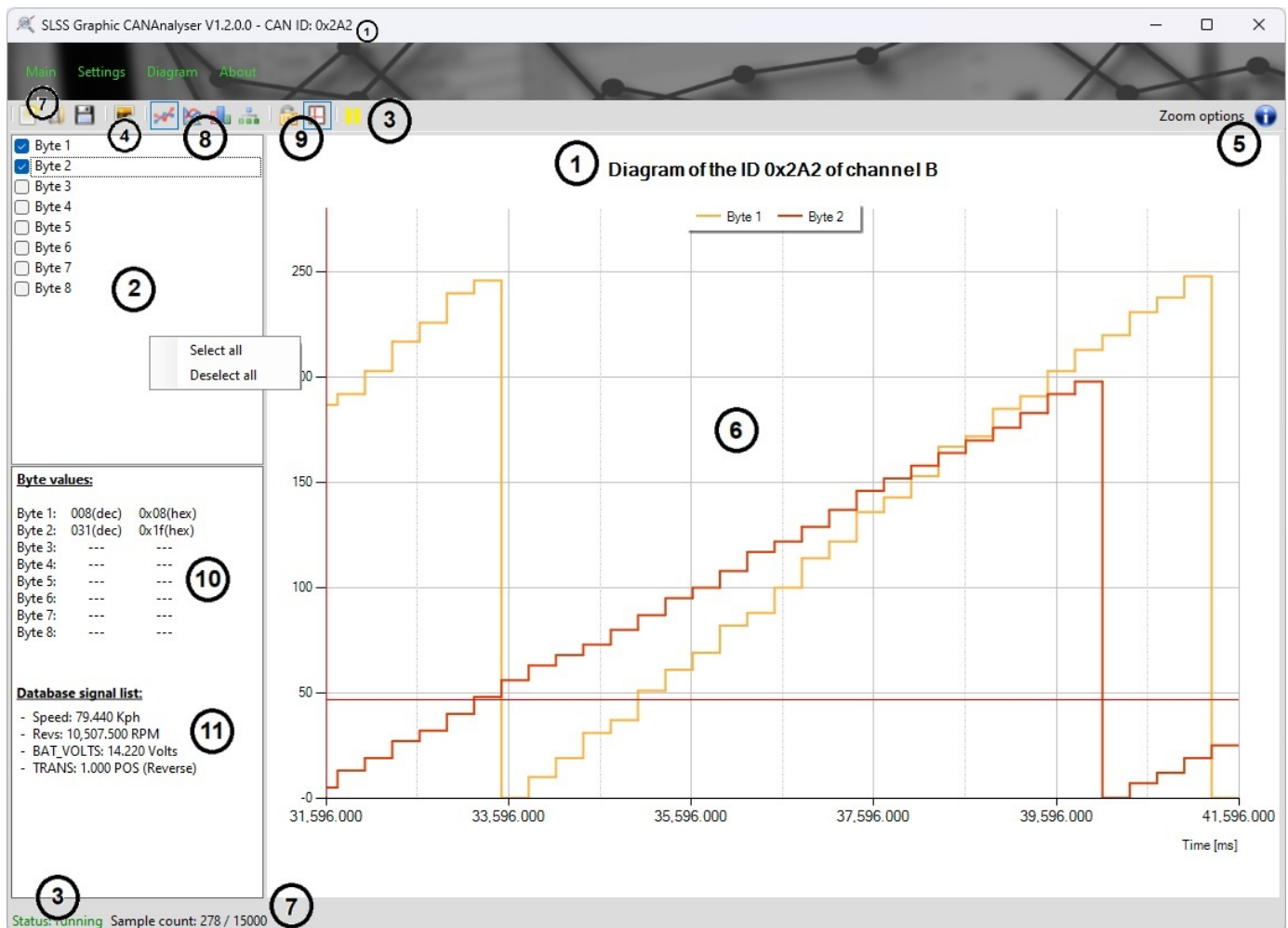

1. This shows the CAN ID identifier and Channel
2. Individual bytes may be enabled / disabled on the graphical viewer as well as buttons to turn them all on / off and reset them. (Right click to bring up the option to select / deselct all messages).

Support for all 64 bytes in CAN FD is possible

3. The **Play** and **Pause** button located in top bar of the viewer for easy access to pause the Incoming data whenever necessary and then play it again. Play and Pause status is shown in the bottom left corner
4. Pressing this button will export a screenshot of the graph in .PNG image file format
5. **Please see the next sub-section for details for changing and zooming the view options**
6. This is the main graphical viewing area. Moving the mouse in this area will also show the X and Y coordinates of the precise position.
7. This shows how many data samples have been collected during the graphical function processing
8. These buttons allow for different graph formats (standard / spline / area / point)
9. These button allow for hiding the cursor or locking its position
10. This area provides the updated matching byte values in DEC and HEX
11. If a database file is loaded, this area shows the human readable translation of the data in real time

3.5.1. Adjusting the View and Zoom of the graphical analyser

Hovering the mouse cursor over the blue i button in the top right corner will show this zoom option box. Those are the shortcuts for adjusting the desired zoom area.

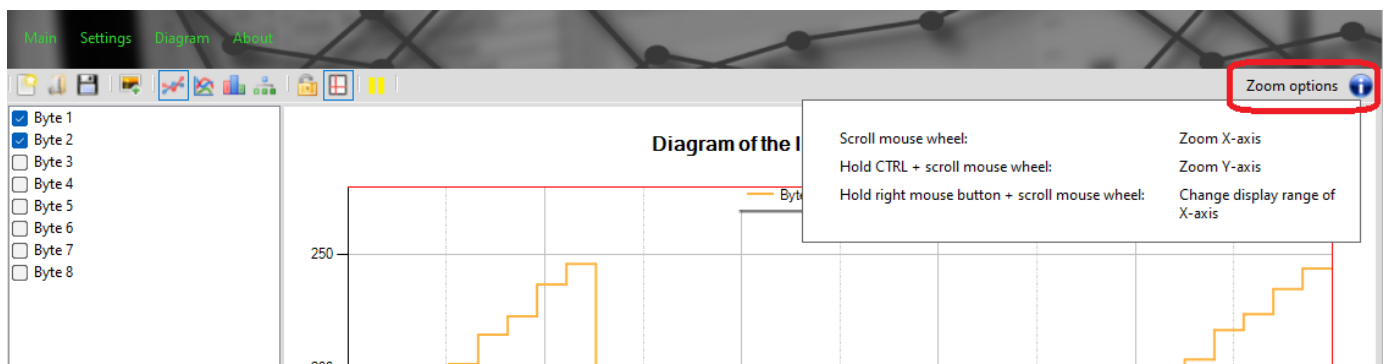

By right-clicking anywhere in the graphing area, another zoom shortcut menu is seen for keyboard shortcuts to manipulate different zoom functions.

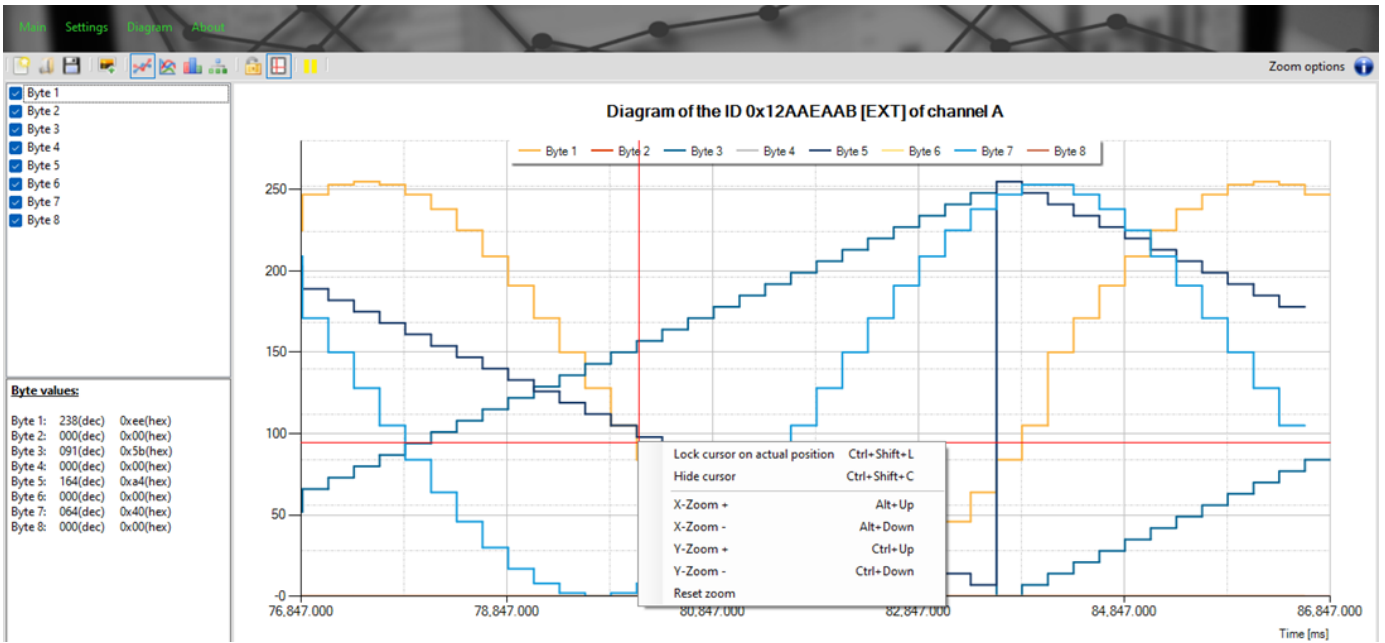

Anytime the graph view needs to be reset, select "Reset zoom"

3.6. Storing / Recalling Full Sessions Containing all Settings



This is key for efficiency for testers work setup and sharing the setup with other testers / users

Once a session has been fully set up including loading database files, message send lists and filters, a User may save the full session setup and may even share that with others. The red box highlights in the screenshot here show all the locations of the saved settings.

The screenshot shows the software's main interface. At the top, there are menu options: Main, Settings, File Handling, Additional Windows, CAN Interface, and About. Below this, there are several configuration sections:

- Hardware and Channel:** Choose hardware (COM3 (CAN-Device-10018D)), Choose channel (Both Channels), and a Disconnect button.
- Transmission and Display:** Transmission speed (500 | 4000), ID display format (Hexadecimal), and Data display format (Hexadecimal).
- Project Information:** Project Name (Jan. 2026 customer project save), Creation Date, and Information Text.
- Tools and Actions:** A toolbar with icons for various functions, including a save icon (circled 1), a database icon (circled 2), and a message icon (circled 3).
- Data Table:** A table with columns: ID, Channel, Count, Data type, Data length, Data, Change Count, Interval [µs], ASCII Text, and Designation. The table contains several rows of CAN bus data.

1. Enter a Project Name that is desired to be saved. Suggestions may include related dates, test cases, project names, tester name, etc.
2. Press this to save the session. Choose the folder to save to and provide a meaningful save name.

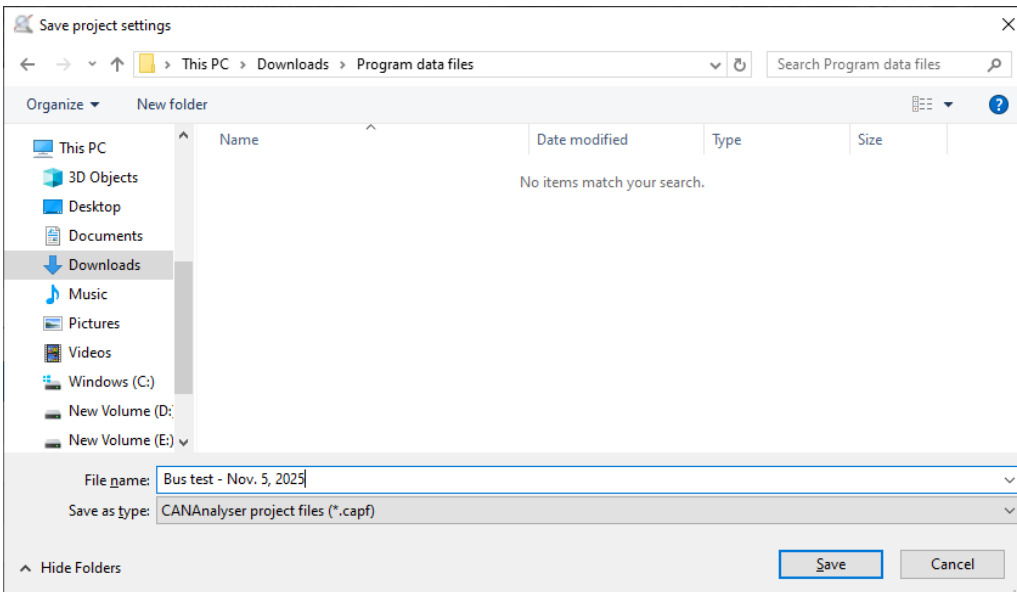

Note the folder location. Saving the file creates an entire folder with all setup information. A user may provide this intact folder to someone else to share a saved setup

- To load a previously saved project setup, navigate to the folder location with the desired .CAPL file name and select it.

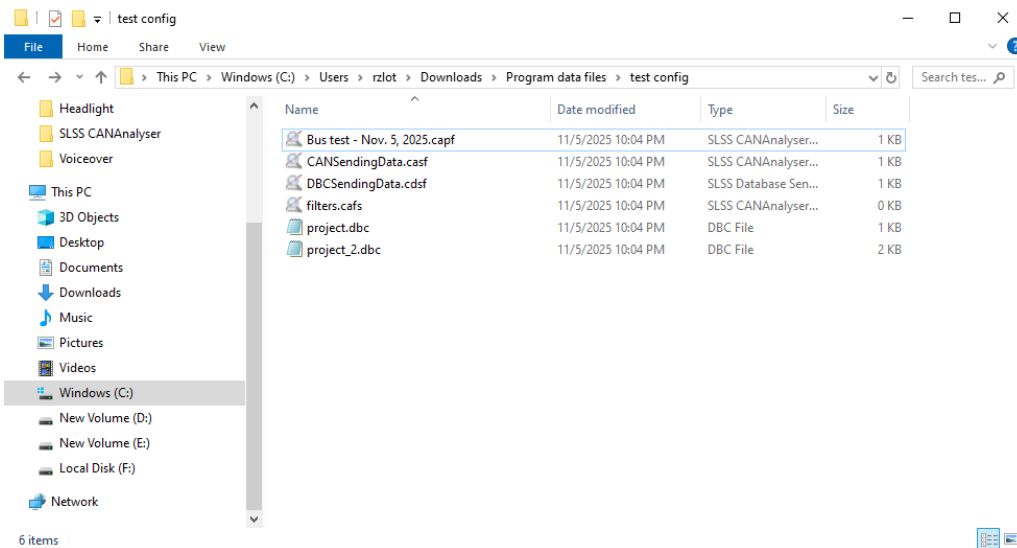

4. Feature Tabs

4.1. Incoming CAN Data Feature Tab

This is the default tab and the most important tab that gives an overview of all current incoming CAN data.

Each column may be shrunk or widened to suit individual preferences. Clicking on the header of each column will also sort the table order based on the column (low to high or high to low)

Incoming Data											Logfile Recorder	Send CAN Messages	Send LIN Messages	Standalone Send Mode	Reverse Engineering	Incoming Database Signals	Send Database Signals
ID	Channel	Count	Data type	Data length	Data	Change Count	Interval (s)	ASCII Text	Designation								
0x123	CH_B	13524	FD	8	0x00 0x00 0x3E 0x00 0x00 0x00 0x00 0x00	13523	200421	>									
0x1FE	CH_A	540723	FD	8	0x43 0x41 0x4E 0x42 0x55 0x53 0x2D 0x31	540722	5009	CANBUS-1									
0x1AB	CH_B	13524	FD	8	0x00 0x55 0x00 0xA1 0x00 0xDF 0x00 0xE4	13523	200419	U j B a									
0x2A2	CH_B	9015	FD	8	0xDC 0xAF 0x86 0x37 0xF3 0xB4 0x43 0x33	9014	300791	U76'C3	Vehicle_Messages * Speed: 450.200 Kph * Revs: 3.553.500 RPM * BAT_VOLTS: 14.580 Volts * TRANS: Undefined_1 POS								
0x44B	CH_B	9014	ESUB	16	0xF1 0xAF 0xA5 0xDC 0x37 0xDE 0x86 0x97 0xEE 0xAF 0x50 0xDC 0x37 0x4E 0x86 0x3B	9013	300803	n707P7P7N[SC]	CANFD_Ext_DBC_Signals								
0x44A	CH_B	9015	FD	24	0xE8 0xAF 0x54 0xDC 0x37 0xE5 0x86 0x9A 0xF3 0xAF 0xA4 0xDC 0x37 0x58 0x86 0xD2 0xF5 0xAF 0x83 0xDC 0x37 0xFD 0x86 0x53	9014	300809	e7U7a67=U7X0a7U7yS	CANFD_DBC_Signals								
0x556	CH_B	2705		8	0x42 0x55 0x53 0x2D 0x32 0x20 0x43 0x41	2704	1377045	BUS-2 CA									
0x7AF	CH_A	13518	FD	8	0x00 0xB1 0x00 0x9C 0x00 0x42 0x00 0x2B	13517	200466	± I B +									

- ID** - Displays the Arbitration ID of each unique CAN message received or sent
- Channel** - Displays the source of the CAN data for each row:

Channel	Data Source
CH_A	Data received from the bus into the hardware module on CAN bus CH-A
CH_B	Data received from the bus into the hardware module on CAN bus CH-B
SEND_A	Data sent from the hardware module on to CAN bus CH-A
SEND_B	Data sent from the hardware module on to CAN bus CH-B



SEND_A and SEND_B entries will only be shown if the hardware dongle receives an acknowledgement on an active bus. Therefore if the dongle is not connected to a bus where the send function receives verification that the message was sent, these entries will not be shown on this view.

- Count** - The count of how many times the CAN ID was sent or received, regardless if there was any change in Byte data

4. **Data type** - This is the type of data for this row. **If this field is blank then the message is a CAN 2.0 format**

[EXT] = CAN 2.0 Extended ID

[EXT] [FD] = CAN FD Extended ID

[FD] = CAN FD

[FD] [BRS] = CAN FD Bit Rate Switch

5. **Data Length** - The number of bytes for the CAN ID

6. **Data** - Displays the data bytes (up to 64 for CAN FD) for the CAN ID. *(Note the red colored entries. This is the changing byte highlighting. This will be described in more detail in the next sub-section)*

7. **Change Count** - The count of how many times the data changed for the CAN ID

8. **Interval (µs)** - The time delta in microseconds between each time this message is received

9. **ASCII Text** - Displays the concatenated ASCII converted data of the data bytes for the CAN ID. Note that to display certain ASCII special items, this is the nomenclature to represent these special characters:

[CR] = carriage return [LF] = line feed [SC] = semicolon'

10. **Designation** - Human readable message name of the CAN ID. *This only populates if a valid database file has been loaded*

11. If a valid database is loaded and the Designation is shown, clicking on the CAN ID will expand that Designation box to show the human readable CAN signals for that row. If there multiple IDs with data in the Designation column, only the Designation name will be shown unless selecting the row to expand to view the signals for that Designation. Note only one row shows at a time. (see image here)

Incoming Data		Logfile Recorder	Send CAN Messages	Send LIN Messages	Standalone Send Mode	Reverse Engineering	Incoming Database Signals		Send Database Signals
ID	Channel	Count	Data type	Data length	Data	Change Count	Interval [µs]	ASCII Text	Designation
0x123	CH_B	1076	FD	8	0x00 0x00 0x00 0x00 0x00 0x00 0x00 0x3E	1075	200226	>	
0x1AB	CH_B	1075	FD	8	0x00 0x99 0x00 0xF5 0x00 0x97 0x00 0x73	1074	200229	δ s	
0x2A2	CH_B	716	FD	8	0xA4 0x3D 0x34 0x05 0xEB 0x82 0x44 0x9D	715	300154	n=4 eD	Vehicle_Messages • Speed: 157.800 Kph • Revs: 333.000 RPM • BAT_VOLTS: 14.100 Volts • TRANS_2_POS
0x44B	CH_B	716	EXT FD	16	0xEE 0x3D 0x46 0xA4 0x05 0x04 0x34 0xF2 0xF0 0x3D 0x82 0xA4 0x05 0x11 0x34 0x02	715	300147	!F= 4δδ= 4	CANFD_Ext_DBC_Signals
0x44A	CH_B	716	FD	24	0xE6 0x3D 0xAE 0xA4 0x05 0x5B 0x34 0x19 0xE7 0x3D 0x98 0xA4 0x05 0x34 0x57 0xF1 0x3D 0x34 0xA4 0x05 0x8D 0x34 0x63	715	300159	æ=8 4 c= 4Wfi=4 4c	CANFD_DBC_Signals
0x1FF	CH_B	430	FD	12	0x00 0x00 0x62 0x00 0x00 0x00 0x00 0x9D 0x00 0x00 0x0C 0x9D	429	501414	b	
0x404	CH_B	430	FD BRS	12	0x00 0x00 0x62 0x00 0x00 0x00 0x00 0x9D 0x00 0x00 0x0C 0x9D	429	501408	b	



The Maximum number of signals that may be viewed is 27 due to row height limit in the Incoming data tab. To view the full set of signals, use the "Incoming database Signals" tab or export and view in the datalogger to view output offline

4.2. CAN Logfile Recorder Feature Tab

This feature tab is used to display and store a running log of all data received sequentially. This data may be saved or exported for further analysis.

Time	Δt Start [µs]	Δt Message [µs]	ID	Channel	Data type	Data length	Data	ASCII Text	Designation
10.01.2026 20:36:47...	25587	224	0x020	CH_A	13	8	0x00 0xFA 0x46 0x00 0x0A 0x00 0x00 0x00	úf [LF]	
10.01.2026 20:36:47...	25618	31	0x2A2	CH_B	13	8	0x75 0x09 0xDC 0x38 0xE7 0x5C 0x67 0xA3	uÜ8çgE	Vehicle_Messages * Speed: 24.210 * Revs: 3.639.000 * BAT_VOLTGS: 13.860 * TRANS: _3
10.01.2026 20:36:47...	25851	233	0x1AB	CH_A	13	8	0x00 0x7D 0x00 0x6D 0x00 0xB4 0x00 0xFB	} m ` ú	
10.01.2026 20:36:47...	25934	83	0x7AE	CH_A	10:235	8	0x9B 0x00 0xE7 0x00 0xF1 0x00 0x36 0x00	ç ñ 6	
10.01.2026 20:36:47...	26023	89	0x7AF	CH_A	10:235	8	0x00 0x96 0x00 0x06 0x00 0x1C 0x00 0x25	ü %	
10.01.2026 20:36:47...	26069	46	0x44B	CH_B	33:13	16	0xEC 0x09 0x5A 0x75 0x38 0xBA 0xDC 0xC8 0xEF 0x09 0x71 0x75 0x38 0x5B 0xDC 0xFA	izu8ÜÈiqu8Üú	CANFD_Ext_DBC_Signals * Population: -370,320,771,304,583,688 * Astronomical Distance: -3,973,096,020
10.01.2026 20:36:47...	26575	506	0x44A	CH_B	13	24	0xEF 0x09 0x60 0x75 0x38 0xD9 0xDC 0xE0 0xF7 0x09 0x38 0x75 0x38 0x81 0xDC 0xBD 0xF1 0x09 0x3B 0x75 0x38 0x78 0xDC 0x87	ı u8Üüa+8u8Ü%fi[SC]u8xÜ	CANFD_DBC_Signals * signal3: -865,691,219,983 * signal2: -47,657,922,261,801 * signal1: -2,243,679,677,827

1. As described in earlier sections, the play / pause / record / stop buttons have a direct impact on the data logger and the summary of the unique ID's and total collected data are still displayed
2. The data will scroll down vertically with new data appearing in the top row and pushing older data down and off the screen
3. All recorded data may be exported either the native format or CSV, TRC or ASC formats

4.3. Send CAN Messages Feature Tab

This feature tab is used to allow the user to create and send single or multiple CAN messages onto the bus. By default, data will be sent in the Periodic mode. More details will be listed below.

ID	Extended	CAN FD message	CAN FD Bit Rate Switch	Send channel	Start Stop send message	Number sent	Transmission period [ms] (editable)	Raw data	Raw data hex	Designation	Send once	Edit	Delete	
0x3B2	<input type="checkbox"/>	<input type="checkbox"/>	<input type="checkbox"/>	CH_A	<input checked="" type="checkbox"/>	0	100	68 76 16 1 230 5 0 34	0x44 0x4C 0x10 0x01 0xE6 0x05 0x00 0x22		send	edit	delete	▲▼
0x048	<input type="checkbox"/>	<input checked="" type="checkbox"/>	<input checked="" type="checkbox"/>	CH_A	<input checked="" type="checkbox"/>	0	100	0 0 0 0 7 0 224 0	0x00 0x00 0x00 0x00 0x07 0x00 0xE0 0x00		send	edit	delete	▲▼
0x2E3	<input type="checkbox"/>	<input type="checkbox"/>	<input type="checkbox"/>	CH_A	<input checked="" type="checkbox"/>	0	1000	2 0 0 0 0 0 0	0x02 0x00 0x00 0x00 0x00 0x00 0x00 0x00		send	edit	delete	▲▼

1. Enter the ID and the byte data that is desired to be added to the send list. Only 8 bytes are displayed at a time. For a CAN FD message, use the scroll (red highlight above) to move through all 64 bytes. To jump back to B1, press the green arrow (orange highlight above). To delete all byte entries, press the trash can icon (orange highlight above). Once the message is fully entered, press the button with the green plus sign to add it to the end of the list below



CAN 2.0 supports sending any number of bytes from 1 to 8, however, moving beyond the first 8 bytes, CAN FD requires these sets of bytes to be fully populated. 12 bytes, 16 bytes, 20 bytes, 24 bytes, 32 bytes, 48 bytes, 64 bytes. Failure to fill in all bytes up to the next break-point will end up in a truncation of the additional bytes beyond the last valid byte barrier.



Do not add send messages with the same ID having CAN FD bit rate switch and without FD only (no bit rate switch) This will cause bus errors

2. When viewing this feature tab while messages are being sent, this column shows a count of how many times each message was sent.
3. When viewing this feature tab while messages are being sent, the checkboxes may be checked or unchecked dynamically to turn on and off sending of individual messages on the list if desired.
4. The transmission / delay period may be changed dynamically by double-clicking in the cells on this column if desired as a fast way to edit the transmission speed.
5. At any time, the user may press the **Send** button to manually send any message once (regardless of whether the messages are automatically sending or not).
6. To edit an existing message entry in the table, select **Edit** to open a window of parameters to change and then **Save changes**.
7. Select **Delete** to delete a message entry from the table.
8. The up and down arrows may be used to move a message up or down the list order. Note that this is not useful in Periodic mode but it is useful on the Serialized mode.
9. The data type of the message ID may be set by setting these checkboxes
 - Extended
 - CAN FD message
 - CAN FD bit rate switch (selecting this checkbox forces the CAN FD message checkbox to be selected)
 - Not selecting any of these checkboxes means that the message will be send as CAN 2.0
10. The drop-down box allows the message to be selected to send to either Channel A, Channel B or both channels
11. The load and save icons are used to load a previously saved list of messages to send or to save the current list. Note that a saved file can be also opened as a macro (see next sub-section)



Saved files from the Send Messages tab (.CASF) and the Standalone tab (.CSSF) and **PEAK**™ (.XMT) may be opened

12. Pressing this button toggles between sending / stopping the list of messages to be sent to the bus.

13. Select the box to move between Periodic or Serialized messages to be sent. When Periodic is selected, the 2 boxes under it are grayed out and not required, however, when Serialized is selected, the user may specify a set number of passes that the list should be sent and if a delay time is desired at the end of the list before starting the next pass.
14. The global Start and Stop and Database Start and Stop sending buttons work in all tabs. Note that the green arrow in the icon means that there are messages that can be sent and pressing it turns the arrow red to show that it is sending. If that arrow is red, pressing it will stop sending and then turn the arrow green. If the arrow is grey, that means there are no messages ready to be sent yet and messages will need to be added first
15. This will enter the Macro sending options mode (see next sub-section)
16. This button will erase the entire send list

4.3.1. Separate Selection of Send Notation

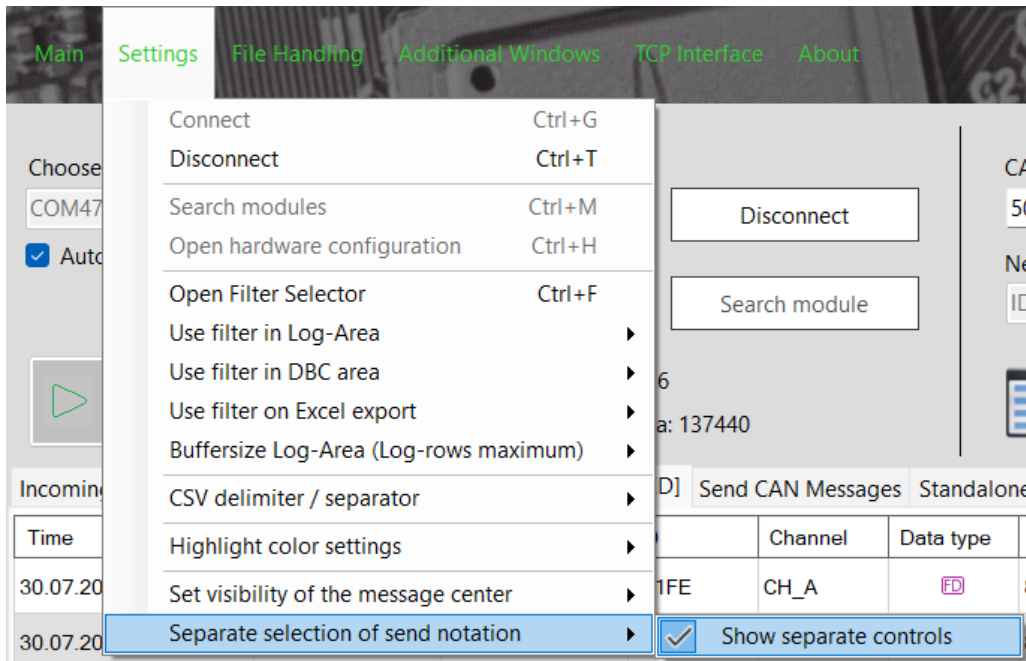

This menu item only impacts the Send Messages area. This allows the user to specify if they want to use separate send notations from the mean CAN ID display format. Note that using the separate send notification allows the user to specify either Decimal or Hexadecimal in the Send message formatting.

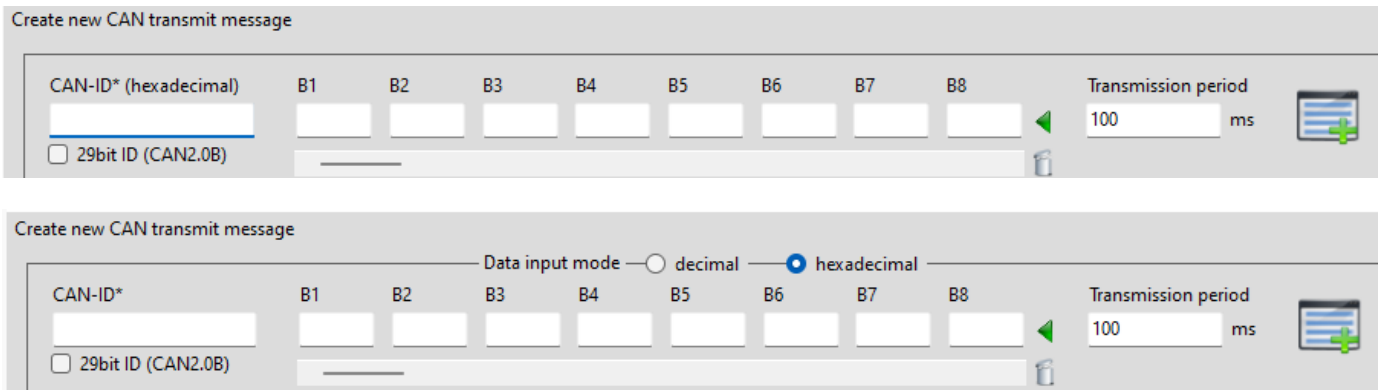

4.3.2. Send Macro Messages

This sub-section will describe how to make use of the macros feature. There are 6 macro slots that may be used.



There can only be one visible send list so the active list of messages is still tied to the regular send button.

ID	Extended	CAN FD message	CAN FD Bit Rate Switch	Send to channel	Start Stop sending message	Number sent	Transmission period [ms] (editable)	Raw data	Raw data hex	Designation	Send once	Edit	Delete
0x3B2	<input type="checkbox"/>	<input type="checkbox"/>	<input type="checkbox"/>	CH_A	<input checked="" type="checkbox"/>	0	100	68 76 16 1 230 5 0 34	0x44 0x4C 0x10 0x01 0xE6 0x05 0x00 0x22		send	edit	delete
0x048	<input type="checkbox"/>	<input type="checkbox"/>	<input type="checkbox"/>	CH_A	<input checked="" type="checkbox"/>	0	100	0 0 0 0 7 0 224 0	0x00 0x00 0x00 0x00 0x07 0x00 0xE0 0x00	11	send	edit	delete
0x2E3	<input type="checkbox"/>	<input type="checkbox"/>	<input type="checkbox"/>	CH_A	<input checked="" type="checkbox"/>	0	1000	2 0 0 0 0 0 0	0x02 0x00 0x00 0x00 0x00 0x00 0x00 0x00		send	edit	delete

1. The red M button toggles the macros at the bottom of the active send list. **Note that the Macro button is on the main buttons at the top of the screen.** If the macros are toggled off, macros cannot be used
2. This is the name of the file of the loaded macro in each slot. If a file is not loaded in one of the slots, it will say (empty)
3. The open button allows a previously saved list of sent messages to be loaded as a macro
4. If it is desired to view / edit the messages from the macro, pressing this button will replace the active send list data with the data from the macro. **If the current visible send list has different data than the macro, a context box will ask if you want to save the current active send list before overwriting it**
5. Toggles the send mode between periodic and serialized
6. Sends the macro once
7. Sends the macro infinitely until stopped
8. Removes the macro from the list
9. Opens a master list of macros that prefills all 6 slots
10. Saves the current list of 6 macros into a single reloadable file to repopulate the macros
11. This is the active send list.

4.4. Reverse Engineering Feature Tab

This feature allows the user to locate the specific target bytes or bits that are changing in a specific Arbitration ID based on a set of criteria. This is useful if the user knows the ID of an action on the bus, however the user needs to find out the specific data that is changing within that ID. The data may be search by bytes or bits as a criteria.

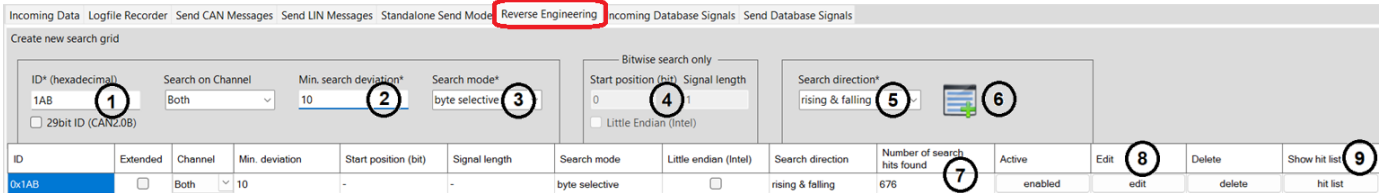

1. Specify the target Arbitration ID
2. Specify the deviation limit of data change (in decimal value) of what is being searched for in the data changes
3. This is the drop-down to select if the search should be done with the byte selective or bit selective method
4. This is only accessible when the user selects a bit selective search mode (see next sub-section for details)
5. To narrow down the deviation, the user may select a matching hit if the data deviation is either rising or rising and falling from the nominal value specified in the Min. search deviation
6. Pressing this button adds the search criteria to the list and the search begins immediately based on the current traffic on the bus
7. As the search criteria matches a hit on the bus, this number will increase to let the user know there is a match to the search criteria
8. There are 3 buttons here to interact with rows in the existing search items. The first button allows the search row to be enabled or disabled. The second button lets you edit the search criteria. The third button will delete that search criteria row
9. To view the matching hits, pressing this button opens the hit list window shown here:

SLSS CANgineer - list of search results

5

ID (* = extended)	Location (byte) [bit - length]	Value at start (decimal)	Value at start (binary)	Value at end (decimal)	Value at end (binary)	Value change (decimal)
427	(B2)	117	0000000001110101	201	0000000011001001	84
427	(B4)	135	0000000010000111	164	0000000010100100	29
427	(B4)	164	0000000010100100	216	0000000011011000	52
427	(B6)	33	0000000001000001	220	0000000011011100	187
427	(B8)	71	0000000010000111	130	0000000010000010	59
427	(B2)	36	000000000100100	47	000000000101111	11
427	(B4)	41	000000000101001	216	0000000011011000	175
427	(B6)	25	000000000011001	220	0000000011011100	195
427	(B8)	31	000000000011111	130	0000000010000010	99
427	(B2)	36	000000000100100	161	0000000010100001	125
427	(B8)	31	000000000011111	45	000000000101101	14

1. This column shows which byte contains the target location of the matching hit in the specified arbitration ID (showing in Decimal)
2. These columns show the decimal and binary value of the start of the change
3. These columns show the decimal and binary value of the end of the change
4. This column shows the delta of the value change to match the hit criteria
5. The table may be saved and also a previously saved table may be loaded for reviewing again.

4.4.1. Bit Selective Method

Incoming Data Logfile Recorder Send CAN Messages Send LIN Messages Standalone Send Mode Reverse Engineering Incoming Database Signals Send Database Signals

Create new search grid

ID* (hexadecimal) 1AB Search on Channel Both Min. search deviation* 10 Search mode* bit selective

29bit ID (CAN2.0B)

Bitwise search only

Start position (bit) 0 Signal length 1

Little Endian (Intel)

Search direction* rising & falling

1. With the search mode changed to a bit selective search, the options in the box to the right of this drop-down become available
2. Choose the starting bit position for the search criteria. Note that bits go from 0 to 63 on the bus data for CAN 2.0 (representing 8 bytes) or from 0 to 511 for CAN FD (representing 64 bytes)
3. Choose the number of bits in length. For example, if the starting bit position is 16 and the length is 16 bits then the search will be from bit position 16 to end at 32.

4.4.2. Reverse Engineering CANgineer Search Parameters

Load and save search parameters from Reverse Engineering Tab

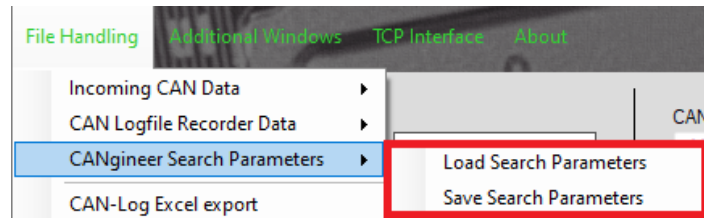

4.4.3. Reverse Engineering CANgineer Result Window

View the data results from the Reverse Engineering feature.

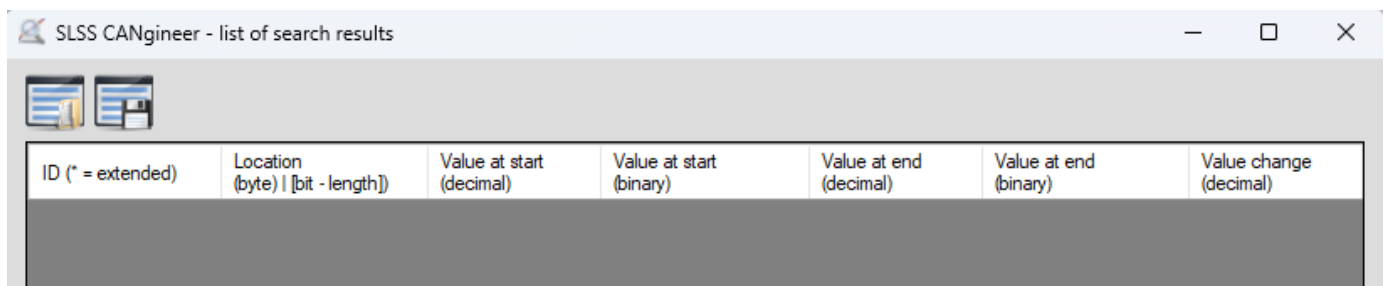
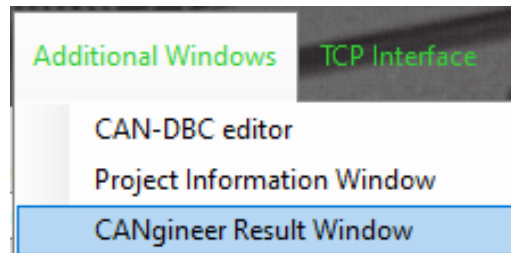

There is the ability to Load and save the data from the Result Window.

4.5. Incoming Database Signals Feature Tab

This feature tab is used to see the human readable information to match the CAN ID to the specific messages and signal names. Database data is able to be uniquely loaded for each channel independently. This tab also shows other non-human readable contextual data about the construct of the signals. Database support is provided for CAN 2.0 and CAN FD DBC files as well as LIN LDF files.

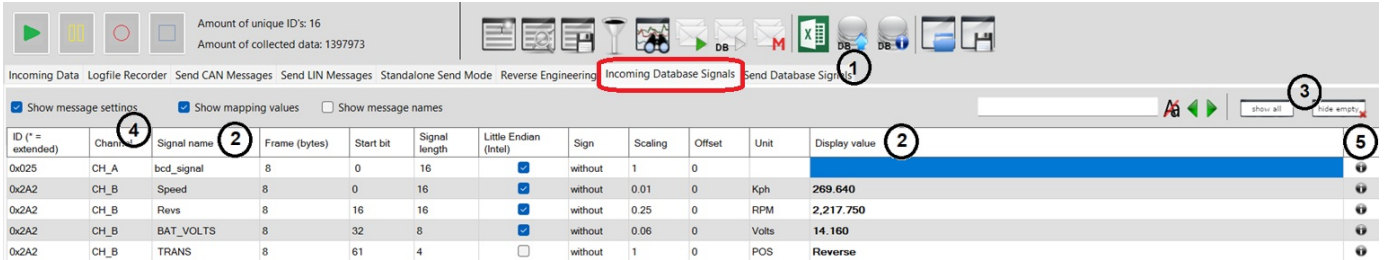

1. This opens a dialog box to allow the user to load a Database file to apply to each channel as well as editing and saving.
2. The human readable signal name, message name and display values are shown here.
3. By default, the Database will load and populate the view for ALL CAN ID's that match to the database file. If it is desired to monitor live CAN bus traffic data in real time to see only the actual data messages on the bus then pressing the **hide empty** button will hide all rows that do not match live CAN data on the bus to make it easier to view. Pressing the **show all** button will revert back to show the entire list again.
4. Informs the user which bus this database signal applies to.
5. The "i" button will be lit up blue if there is detailed additional information about that particular signal. Click on the blue "i" button for additional information.

4.5.1. Enhancing Logdata with Human Readable Signal Data

The screenshot shows the CAN Logfile Recorder interface. At the top, there are controls for hardware selection (COM3), channel selection (Both Channels), and transmission speed (500 | 4000). A table of log messages is displayed with columns for Time, Δt Start [μs], Δt Message [μs], ID, Channel, Data type, Data length, Data, ASCII Text, and Designation. A dialog box titled "Enhance the log data?" is overlaid on the table, asking "Loaded database data was found. Do you wish to enhance the log export with database data?" with a "Yes" button and a "No" button. A progress bar is visible in the background of the dialog box.

Time	Δt Start [μs]	Δt Message [μs]	ID	Channel	Data type	Data length	Data	ASCII Text	Designation
10.01.2026 22:22:56...	0	0	0x1FE	CH_A	FX	8	0x87 0x00 0x00 0x00 0x00 0x00 0x00 0x00	0	
10.01.2026 22:22:56...	5011	5011	0x1FE	CH_A	FX	8	0x8C 0x00 0x00 0x00 0x00 0x00 0x00 0x00	0	
10.01.2026 22:22:56...	10019	5008	0x1FE	CH_A	FX	8			
10.01.2026 22:22:56...	15026	5007	0x1FE	CH_A	FX	8			
10.01.2026 22:22:56...	20034	5008	0x1FE	CH_A	FX	8			
10.01.2026 22:22:56...	25045	5011	0x1FE	CH_A	FX	8			
10.01.2026 22:22:56...	30051	5006	0x1FE	CH_A	FX	8			
10.01.2026 22:22:56...	35062	5011	0x1FE	CH_A	FX	8			
10.01.2026 22:22:56...	40069	5007	0x1FE	CH_A	FX	8			
10.01.2026 22:22:56...	45090	5021	0x1FE	CH_A	FX	8			
10.01.2026 22:22:56...	45119	29	0x123	CH_B	FX	8			
10.01.2026 22:22:56...	45358	239	0x010	CH_A	FX	8			
10.01.2026 22:22:56...	45389	31	0x1AB	CH_B	FX	8			
10.01.2026 22:22:56...	45633	244	0x020	CH_A	FX	8			
10.01.2026 22:22:56...	45664	31	0x2A2	CH_B	FX	8	0x09 0x99 0x33 0x2B 0xF6 0x99 0x07 0xAD	3+αII-	Vehicle_Messages

1. If a Database file is loaded and the user presses the STOP button, a context box will ask if the user desires to enhance the log files. This will take some time to post-process and add all of the Database human readable signal data to the logfile and will be available in the exports.
2. If the user chooses to enhance the log data, a pop-up window will inform the user of the short progress bar to enhance the logs and then the box will close when it is completed (see image below)
3. Upon the completion of the log enhancement process, any saving of the data or the export (CSV or Excel) will include an enhanced data logging file that includes the Designation as well as the list of all human readable signals for each Arbitration ID for each data change.

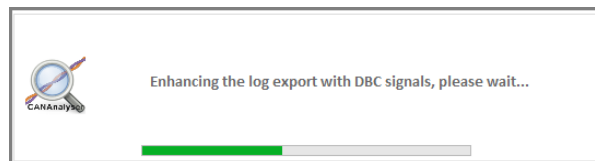

Example from an Excel export:

Overview CAN Logfile recorder view
 SLSS CANAnalyser - Excel export creation time: Thursday, November 16, 2023 23:28:28.0575956

Time	Δt Start [μs]	Δt Message [μs]	ID	Channel	Raw Data	ASCII Text	Data B1	Data B2	Data B3	Data B4	Data B5	Data B6	Data B7	Data B8	Designation
16.11.2023 23:27:11.580	7999496	796	0x2A2	CH_B	39 154 95 105 234 9 162 172	⌋é ç	0x27	0x9A	0x5F	0x89	0xEA	0x9	0xA2	0xAC	Vehicle_Messages * KPH: 394.630 * RPM: 6,743.750 * BAT_VOLTS: 14.040 * TRANS: Neutral
16.11.2023 23:27:11.880	8299398	802	0x2A2	CH_B	51 163 113 111 234 144 76 16	3EqøeLJ	0x33	0xA3	0x71	0x8F	0xEA	0x90	0x4C	0x10	Vehicle_Messages * KPH: 417.790 * RPM: 7,132.250 * BAT_VOLTS: 14.040 * TRANS: Park

4.6. Standalone Send Mode Feature Tab

This feature tab is used to configure the hardware dongle to be able to be disconnected from the SLSS CANAnalyser software and be able to be powered via the USB connector or the DB-9 connector to autonomously send a programmed list of up to 40 messages. Once the dongle is reconnected to the SLSS CANAnalyser software again, it will operate as if it were not in Standalone mode and the user may reconfigure it in this feature tab again.



Much of this interface is in common with the Send CAN Messages tab so most of the duplicate items will not be focused on here.

1. Enter a message as desired. Specify the ID and the byte data. Only 8 bytes are displayed at a time. For a CAN FD message, use the scroll (red highlight above) to move through all 64 bytes. To jump back to B1, press the green arrow (orange highlight above). To delete all byte entries, press the trash can icon (orange highlight above).



CAN 2.0 supports sending any number of bytes from 1 to 8, however, moving beyond the first 8 bytes, CAN FD requires these sets of bytes to be fully populated. 12 bytes, 16 bytes, 20 bytes, 24 bytes, 32 bytes, 48 bytes, 64 bytes. Failure to fill in all bytes up to the next break-point will end up in a truncation of the additional bytes beyond the last valid byte barrier.

2. Retrieves a stored list of messages and the hardware settings from the dongle (if the dongle currently has the messages and settings stored).
3. Erases stored message lists and standalone settings from the dongle and will disable the stand alone mode from the dongle when it is not connected to the SLSS CANAnalyser software. This may be reenabled by sending a new list.
4. This is to configure the dongle hardware for its setup configuration for either CAN 2.0 or CAN FD for once it is disconnected from the SLSS CANAnalyser software and functioning independently in standalone mode. Note that this configuration menu is also independent from the configuration menu at the top. Settings may be different.



See connection setting details in the next sub-section

5. This is to send the standalone message list to the dongle as a temporary list. As long as the dongle is still powered, this list will remain in the dongle, however if power is disconnected, this list is not committed to the dongle.
6. This is to send the standalone message list to the dongle as a committed list. Once this is completed, if power to the dongle is disconnected, this list is permanently committed to the dongle until overwritten or erased. Any time the hardware dongle is powered up after this, the Standalone mode will be the initial default mode for the dongle. A connection to the SLSS CANAnalyser software will still allow for normal software connected functionality.
7. For the lower section of the message list itself, this is in common with the Send CAN Messages tab except that there are 2 new columns. A message may now be set as a CAN FD message and if so, it may also be able to be configured to enable the bit rate switch functionality.
8. The load and save icons are used to load a previously saved list of messages to send or to save the current list.



Saved files from the Send Messages tab (.CASF) and the Standalone tab (.CSSF) and **PEAK**™ (.XMT) may be opened

9. This button will erase the entire send list

4.6.1. Standalone dongle hardware configuration settings

CAN Channel	CAN FD active	Arb. bitrate [kbit/s]	FD bitrate multiplicator	Bus interaction mode	Send CAN messages	Configurable termination resistor	Start Delay Time [s]
CH_A	yes	500	x1	normal	enabled	enabled	0
CH_B	yes	500	x1	normal	enabled	enabled	0

Activate manual CAN FD settings for channel A

Clock Frequency	Sample P. (Arb.)	Bitrate (Arb.)	Prescaler (Arb.)	PSEG1 (Arb.)	PSEG2 (Arb.)	SJW (Arb.)	TDC	Get values
80 MHz	80 %	500 kbit/s	1	127	32	32	12	
	Sample P. (Data)	Bitrate (Data)	Prescaler (Data)	PSEG1 (Data)	PSEG2 (Data)	SJW (Data)		Check settings
	80 %	4000 kbit/s	1	15	4	4		

Activate manual CAN FD settings for channel B

Clock Frequency	Sample P. (Arb.)	Bitrate (Arb.)	Prescaler (Arb.)	PSEG1 (Arb.)	PSEG2 (Arb.)	SJW (Arb.)	TDC	Get values
80 MHz	80 %	500 kbit/s	1	127	32	32	12	
	Sample P. (Data)	Bitrate (Data)	Prescaler (Data)	PSEG1 (Data)	PSEG2 (Data)	SJW (Data)		Check settings
	80 %	4000 kbit/s	1	15	4	4		



These configurations are independent for the standalone mode from the main SLSS CANAnalyser behaviors from the hardware configuration settings earlier in this manual

All of the configuration options are in common with the primary software configuration options that are already explained in the section above on the Hardware Configuration window, with the exception of the Start Delay feature. This allows a time delay to be added from the time that the dongle is powered up in Standalone mode until it begins broadcasting the standalone messages programmed into it.

4.7. Send Database Signal Feature Tab

To offer the convenience of simplicity for users to be able to directly send the real world values from a Database file without requiring to manual set your ID and byte data, we offer this feature.

Message received	Receive on channel	Send to channel	Message retransmission trigger	Start / Stop sending message	Number sent	Transmission period [ms] (editable)	Message name	Signal name	Value (editable)	Unit	Send once	Delete
<input type="checkbox"/>	CH_A	CH_B	<input type="checkbox"/>	<input checked="" type="checkbox"/>	0	1000	SG_BatteryConfig	Temperature_Upred	255 (LIN_INIT)	°C	send	delete
<input checked="" type="checkbox"/>	CH_B	Both	<input type="checkbox"/>	<input checked="" type="checkbox"/>	0	500	Vehicle_Messages	TRANS	0 (Park)	POS	send	delete



This tab only provides functionality to add new Signals with a database file loaded!



Functionality of this tab is based on the **Send CAN Messages** tab so all common functionality operates the same and will not be the focus of this sub-section.



If the Database file gets updated after a send Signal list was stored, the Database Send list may need to be changed to match the Signal changes.

1. If 2 Database files are loaded, the list may be extremely large so it is possible to use this dropdown to allow a choice of which database channel to select the signal from, or both channels may be selected.
2. Select the desired Signal name from the dropdown that is intended to be used to send to the bus.
3. Enter the desired Signal value within the allowed range. If data is entered outside the database file determined range, a pop-up will inform the user of the minimum and maximum value range to select from. Values that are entered that do not match the scaler from the selected database file data will be rounded up to the next valid value (including decimal values). The units are automatically populated from the database data.
4. This column will show either a green check box or a red cross-out. The green check box means that this Signal is currently being received on the active bus. The red cross-out means that the Signal is not currently being seen on the active bus.
5. This drop down allows the user to send the desired Signal information to either bus. This is useful if one channel is actively receiving an ID and the value is intended to be modified and sent to the other bus (like a filtered Gateway in essence).
6. Selecting this box means that if the first column has a green check box and the remaining bytes of a CAN ID that are not being impacted by this Signal then this Signal will transit on this with the remaining live data byte values retransmitted from the live incoming data.
7. The values of the Signal may be edited and updated directly here.
8. Global Start and Stop Database Signal send button.

4.8. Send LIN Messages Feature Tab



This tab will only be visible with the addition of the LIN support added to your license. We currently have not yet released the DESK LIN Pro dongles so this will become available in the near future.

Once available, SLSS CANalyser will add the ability to send LIN messages as either a Master or a Slave providing optimal flexibility.

LIN SLAVE SENDING

Incoming Data | Logfile Recorder | Send CAN Messages | **Send LIN Messages** | Standalone Send Mode | Reverse Engineering | Incoming Database Signals | Send Database Signals

Create new LIN slave response message

LIN Slave

LIN-ID* (hexadecimal) B1 B2 B3 B4 B5 B6 B7 B8 Response delay 0 μs

Auto-upload active Enhanced checksum

LIN slave control elements

Slave simulation status: active
Stored slave messages: 5
Last data upload: 01.06.2026 - 19:36:03

ID	PID	Enhanced checksum	Send to channel	Start Stop sending slave response	Response delay [μs] (editable)	Raw Data	Raw Data Hex	Checksum	Designation	Edit	Delete
0x22	0xE2	<input type="checkbox"/>	CH_A	<input checked="" type="checkbox"/>	0	18 34	0x12 0x22	0xCB		edit	delete
0x24	0x64	<input type="checkbox"/>	CH_A	<input checked="" type="checkbox"/>	0	18 34	0x12 0x22	0xCB		edit	delete
0x26	0xA6	<input type="checkbox"/>	CH_A	<input checked="" type="checkbox"/>	0	18 34 10 11 12 13 14 15	0x12 0x22 0x0A 0x0B 0x0C 0x0D 0x0E 0x0F	0x80		edit	delete
0x28	0xA8	<input type="checkbox"/>	CH_A	<input checked="" type="checkbox"/>	0	18 34 170 187 204 221 238 255	0x12 0x22 0xAA 0xBB 0xCC 0xDD 0xEE 0xFF	0xCB		edit	delete
0x29	0xE9	<input checked="" type="checkbox"/>	CH_A	<input checked="" type="checkbox"/>	0	18 34 67 85 86	0x12 0x22 0x43 0x55 0x56	0xF2		edit	delete

LIN MASTER SENDING

Incoming Data | Logfile Recorder | Send CAN Messages | **Send LIN Messages** | Standalone Send Mode | Reverse Engineering | Incoming Database Signals | Send Database Signals

Create new LIN master transmit message

LIN Master

LIN-ID* (hexadecimal) B1 B2 B3 B4 B5 B6 B7 B8 Delay time 100 ms

Master request Enhanced checksum

Send mode: Periodic Serialized

Number of passes * 1 Delay time after end of list 100 ms

* Leave blank to send continually

ID	PID	Master Request	Enhanced checksum	Send to channel	Start Stop sending message	Number sent	Delay time transmission list [ms] (editable)	Raw data	Raw data hex	Checksum	Designation
0x04	0xC4	<input type="checkbox"/>	<input type="checkbox"/>	CH_A	<input type="checkbox"/>	0	100	255 255 255 255	0xFF 0xFF 0xFF 0xFF	0x00	
0x06	0x06	<input type="checkbox"/>	<input type="checkbox"/>	CH_A	<input checked="" type="checkbox"/>	0	100	255 255 255 255	0xFF 0xFF 0xFF 0xFF	0x00	
0x0A	0xCA	<input type="checkbox"/>	<input type="checkbox"/>	CH_A	<input type="checkbox"/>	0	100	255 255 255 255	0xFF 0xFF 0xFF 0xFF	0x00	
0x15	0x55	<input type="checkbox"/>	<input type="checkbox"/>	CH_A	<input type="checkbox"/>	0	100	255 255 255 255	0xFF 0xFF 0xFF 0xFF	0x00	
0x25	0x25	<input type="checkbox"/>	<input type="checkbox"/>	CH_A	<input checked="" type="checkbox"/>	0	100	255 255 255 255	0xFF 0xFF 0xFF 0xFF	0x00	
0x33	0x73	<input type="checkbox"/>	<input type="checkbox"/>	CH_A	<input checked="" type="checkbox"/>	0	100	255 255 255 255	0xFF 0xFF 0xFF 0xFF	0x00	
0x37	0x37	<input type="checkbox"/>	<input type="checkbox"/>	CH_A	<input type="checkbox"/>	0	100	255 255 255 255	0xFF 0xFF 0xFF 0xFF	0x00	

5. Other Menu Options

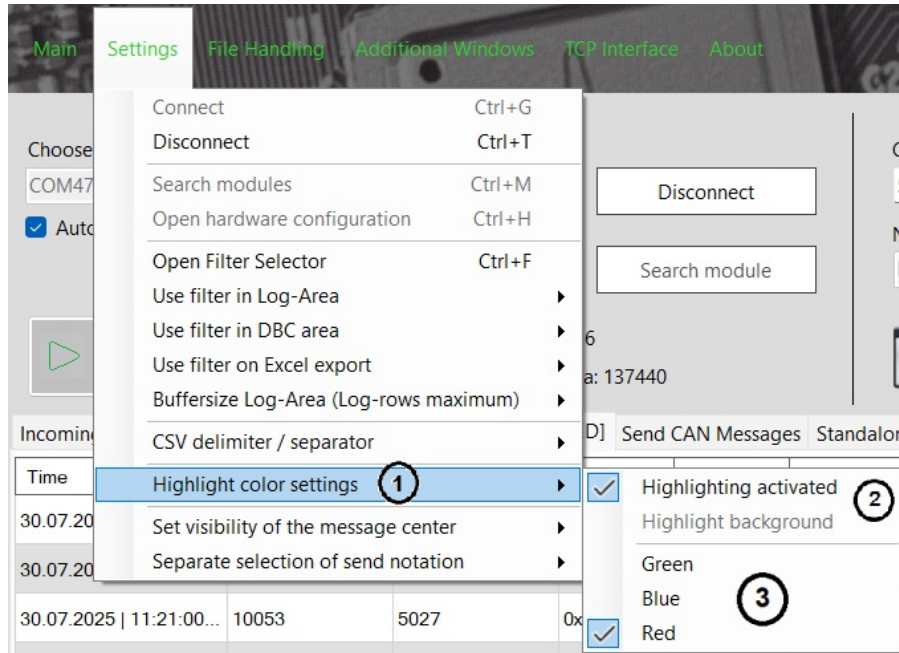

5.1. Byte Highlighting

1. Enter this sub-menu to access the options of the byte highlighting behavior
2. Activate byte highlighting or disable it (It is on by default) or change modes to highlight the background or not
3. Select the color you prefer. Red is the default

This feature allows a visual aid to more easily detect the changing of data bytes. There are 2 styles used in this software.

Color changing of the data	Color changing of the data cell
<code>0x95 0x00 0x1E 0x00 0xB9 0x00 0x64 0x00</code>	<code>0x5F 0x00 0x00 0x00 0x00 0x00 0x00 0x00</code>
<code>0x00 0x78 0x3C 0x00 0x0A 0x00 0x00 0x00</code>	<code>0x00 0x00 0x00 0x00 0x00 0x00 0x00 0x00</code>
<code>0x84 0x00 0xD5 0x00 0x14 0x00 0x5C 0x00</code>	<code>0x11 0x00 0x9C 0x00 0x0B 0x00 0x0E 0x00</code>
<code>0x00 0x37 0x00 0x25 0x00 0xA8 0x00 0xA0</code>	<code>0x00 0x9E 0x00 0x1F 0x00 0xE3 0x00 0xA8</code>
<code>0x96 0x00 0xCE 0x00 0x31 0x00 0xFD 0x00</code>	<code>0x00 0xFA 0x64 0x00 0x0A 0x00 0x00 0x00</code>
<code>0x4E 0x42 0x55 0x53 0x2D 0x31 0x20 0x43</code>	<code>0x00 0xBF 0x00 0x22 0x00 0x06 0x00 0x36</code>

These methods are mutually exclusive and selectable in the setting menu. To change between these modes, you must disconnect first and then change the selection in the settings menu and then reconnect. See next section for details on the setting menu to alternate these or disable the feature.

5.2. Right-Click Menu

Using the mouse Right-click function on most of the tabs provides a menu of quick access tasks to access that are convenient from this location. It is good to left-click and select a cell in a row first to ensure the right-click context menu reacts to the data in the selected row.

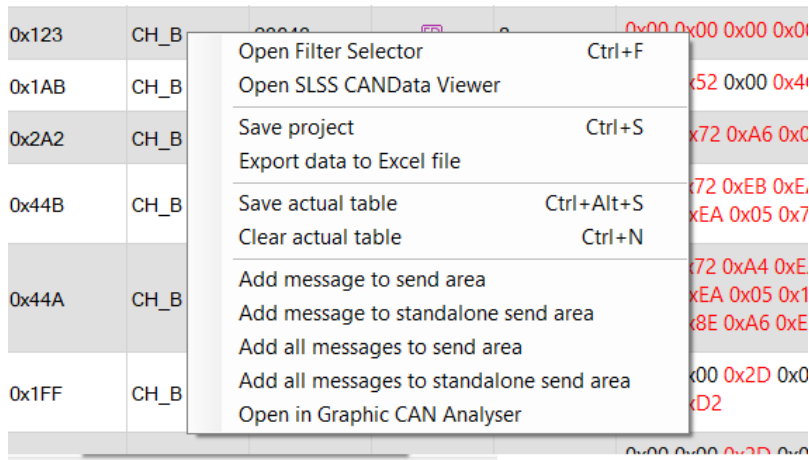

Each of these menu items are shortcuts to the same feature / function offered in other parts of this manual so these are just brief descriptions for each one:

- Opens the message filtering setup in a separate window
- Loads the external CANData Viewer window
- Saves the current project parameters
- Opens the dialog box for choosing your export options and then exports data
- Saves current data from the Incoming CAN Data tab (snapshot of the current messages - 1 per ID)
- Clears the current Incoming data and is ready to be populated again
- Directly adds the current selected ID and data bytes of the selected row into the Send CAN Messages
- Directly adds the current selected ID and data bytes of the selected row into the Standalone Send CAN Messages
- Directly adds ALL IDs and data bytes of the selected row into the Send CAN Messages
- Directly adds All IDs and data bytes of the selected row into the Standalone Send CAN Messages
- Directly opens the current selected ID in the external Graphical Analyser window

5.3. Increase Log Buffer Maximum Size

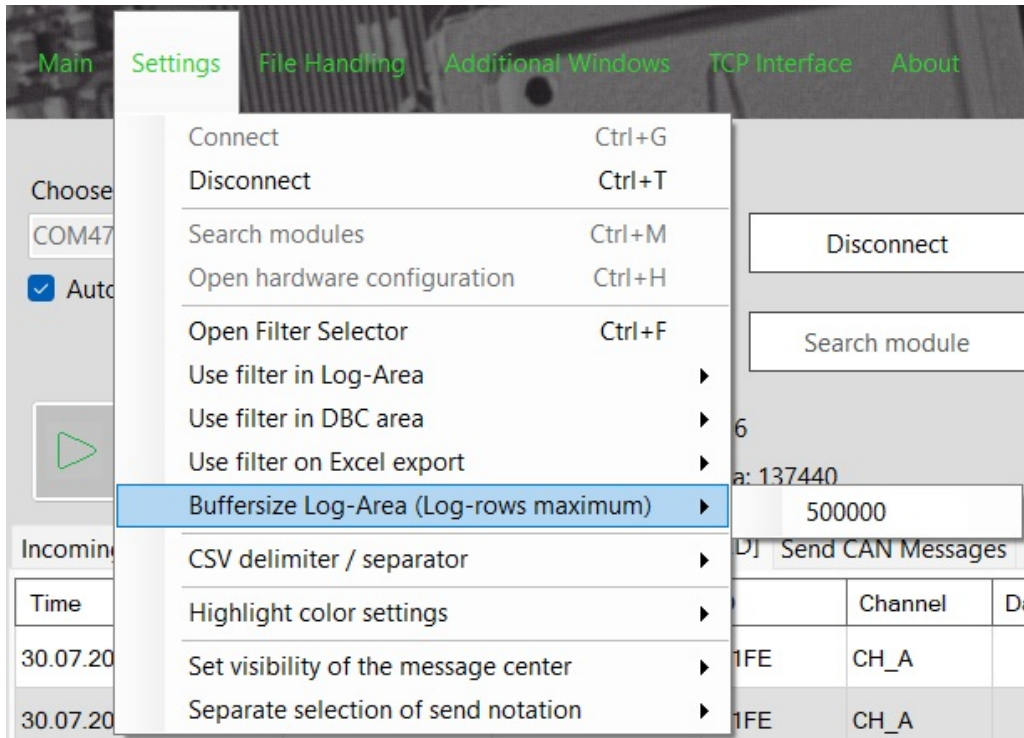

Going into this menu allows you to increase the maximum recording log buffer size. Note that the larger the log buffer, the longer it takes to save the exported data. A value entered higher than the allowed maximum will default to the maximum value.

6. SLSS CANData Viewer

This menu option feature is used to be able to load in a previously saved data session and view the data inside the software

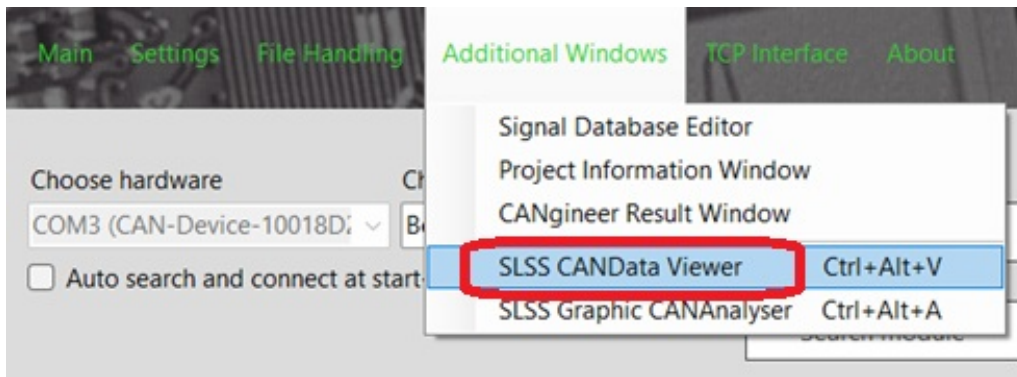

OR

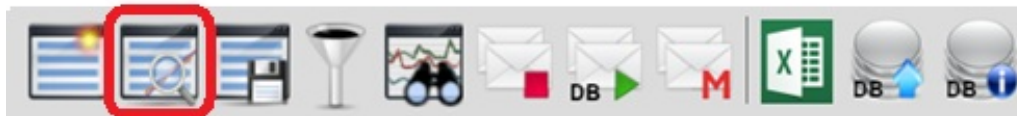

6.1. SLSS CANData Viewer Main Program

All of SLSS CANAnalyser saved file formats are supported.

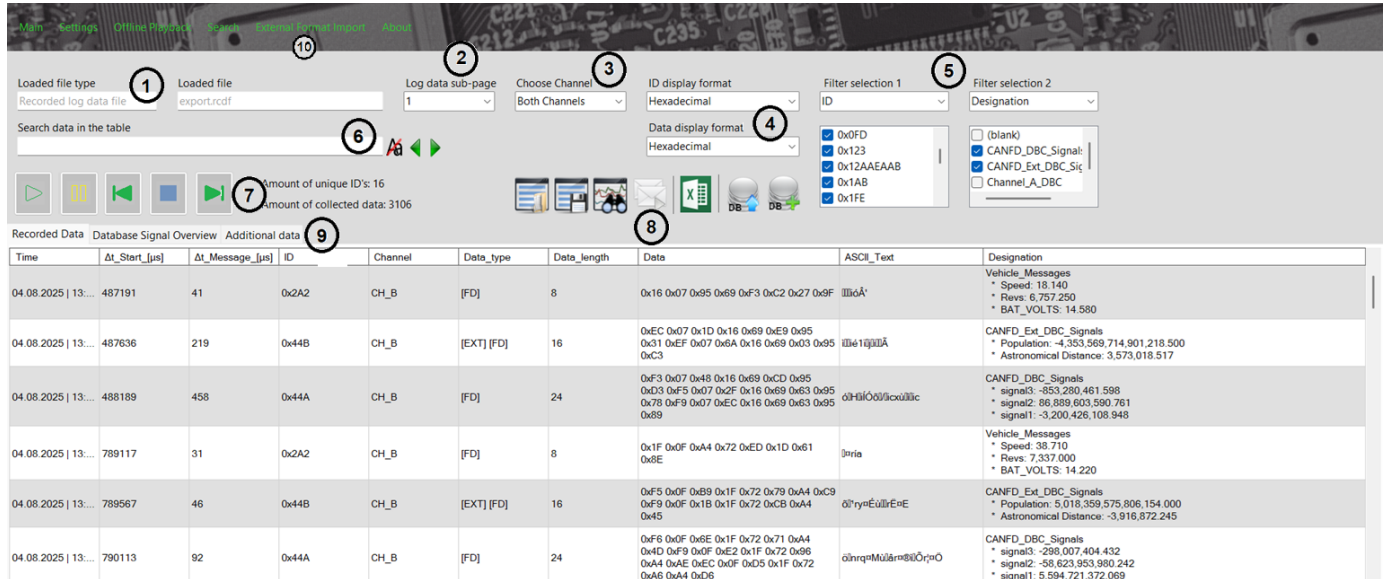

1. Information displayed based on the file loaded. It states the type of file and the file name that was loaded
2. In the case of loading a file that has more than 200,000 rows, to conserve PC memory resources, the data will be broken into sub-pages of up to 200,000 lines per sub-page. This drop-down allows the user to select a different sub-page of data to access
3. This allows the view of only CH_A or CH_B or both channels from the loaded data
4. These drop-downs are used to change the format of either the ID or Byte data (HEX, DEC, BINARY)
5. Filter 1 and Filter 2 may be set to provide 2 layers of filtering of ID or bytes or designation to find the data that is desired. To select or deselect all messages in a filter list, right click on the list and select "Select all" or "Deselect all"

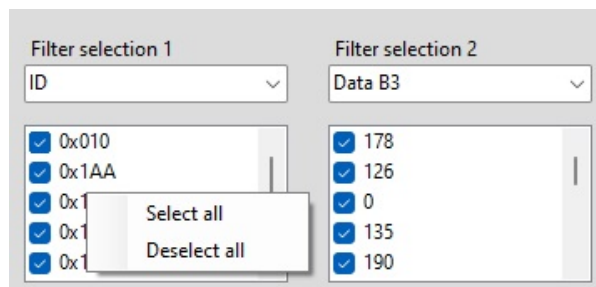

6. This is a data search field. Any text entered here will highlight a cell in blue color for matching criteria. Beside it is an icon to enable or disable case matching. The green arrows beside that will move to the next or previous matched cell
7. These are the data control buttons. From left to right is Play, Pause, Step backwards, Stop, Step forwards. Note, to play back the data, press the play button. The play button must be enabled for the graphical viewer to show the graph

8. These are the feature control buttons. From left to right is the Load data button (loads scdf, scdv, rcdf files), the save button to save a copy of your current filtered data, the graphical analyser button (operates identical to this button in the main software), the playback CAN button (future application to play back recorded data back onto the live bus), Export data button (choose from Excel or CSV), load database file button and then the last button will go through the loaded data rows and enhance it with the loaded database file data
9. There are 4 tabs in the main viewing window. The first 3 operate identically to the way these 3 tabs operate in the main SLSS CANAnalyser software. The Recorded CAN Data tab shows the logged data rows (that can be played back). The Database Signal Overview tab shows all the decoded human readable database signal data that can also be played back to see dynamic data as it changes. The Database Data tab allows the direct viewing of the database file itself. The 4th tab "Additional data" is for imported data such as imported send message data that can be viewed and then converted / saved into the SLSS CANAnalyser format to load into the main software
10. The software currently supports 4 data import formats. **PEAK**™ .TRC V2.0 and V2.1 format log files, **PEAK**™ .XMT send message list files and **ASC** files may be imported. Additionally CSV files that were previously exported from SLSS CANAnalyser format may also be imported



For CSV imports, ensure to select the correct delimiter character under the **Settings** menu.

6.2. Import ASC log files

Select "ASC file import" from this menu to import ASC log files for analysis.

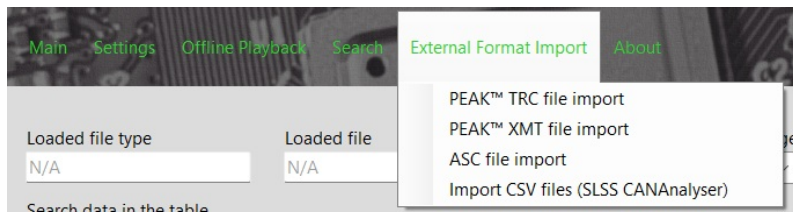

6.3. Loading the Database file and enhancing the logged data (DBC, LDF)

After importing a log file or loading a previously saved log file, the database file may be loaded in order to add the Message / Signal human readable information.

1. Open the window to load the database file
2. Select the file location of the database file for each channel

The screenshot shows the software interface with a 'DBC file selection' dialog box open. The dialog has two input fields for 'DBC File (Channel A)' and 'DBC File (Channel B)'. The file paths entered are C:\Users\rvzlot\Downloads\DBC\Black_box_FD_CHA.dbc and C:\Users\rvzlot\Downloads\DBC\Black_box_FD_CHB2.dbc. A red circle '1' is on the main interface, and a red circle '2' is on the dialog box.

Time	dt_Start_[us]	dt_Message_[us]	ID	Channel	Data_type	Data_length	Data	ASCII_Text	Designation
01.01.2007 00:0...	0	0	0x6AF	CH_A	[FD]				
01.01.2007 00:0...	3683	3683	0x1AB	CH_A					
01.01.2007 00:0...	9153	5470	0x12AAEAAA	CH_A	[EXT]				
01.01.2007 00:0...	20641	11488	0x5AD	CH_A	[FD][BRS]				
01.01.2007 00:0...	35451	14810	0x6AE	CH_A	[FD]	32	0x06 0x06 0x06 0x06 0x06 0x06 0x0a 0x0a 0x0a 0x0a 0x0b 0x0b 0x0b 0x0b 0x0b 0x0b 0x0b 0x0b 0x0b 0x0b 0x0b 0x0b	[LF][LF][LF][LF]	

1. Select "Yes" to enhance the loaded data with the database translations

The screenshot shows the software interface with an 'Enhance the loaded CAN data?' dialog box open. The dialog asks 'Do you wish to enhance the loaded data with DBC data?' and includes a note: 'Note: This process may take some time!'. The 'Yes' button is highlighted with a red circle '1'.

Time	dt_Start_[us]	dt_Message_[us]	ID	Channel	Data_type	Data_length	Data	ASCII_Text	Designation
01.01.2007 00:0...	0	0	0x6AF	CH_A	[FD]				
01.01.2007 00:0...	3683	3683	0x1AB	CH_A					
01.01.2007 00:0...	9153	5470	0x12AAEAAA	CH_A	[EXT]				
01.01.2007 00:0...	20641	11488	0x5AD	CH_A	[FD][BRS]				
01.01.2007 00:0...	35451	14810	0x6AE	CH_A	[FD]	32	0x06 0x06 0x06 0x06 0x06 0x06 0x0a 0x0a 0x0a 0x0a 0x0b 0x0b 0x0b 0x0b 0x0b 0x0b 0x0b 0x0b 0x0b 0x0b 0x0b 0x0b	[LF][LF][LF][LF]	

6.4. Converting imported .XMT files into SLSS CANAnalyser .CASF or .CSSF files

Step 1 - Import the desired .XMT file

Step 2 - Press the save button

ID	Extended	CAN FD message	CAN FD Bit Rate Switch	Send to channel	Sending activated	Repeat periodically	Transmission period [ms]	Raw data	Raw data hex	Designation
0x383	<input type="checkbox"/>	<input checked="" type="checkbox"/>	<input type="checkbox"/>	CH_A	<input checked="" type="checkbox"/>	<input checked="" type="checkbox"/>	50	34 26 3	0x22 0x1A 0x03	Session Management
0x7A3	<input type="checkbox"/>	<input checked="" type="checkbox"/>	<input type="checkbox"/>	CH_A	<input checked="" type="checkbox"/>	<input type="checkbox"/>	0	143 221 26 254	0x8F 0xDD 0x1A 0xFE	Test Mode
0x59E	<input type="checkbox"/>	<input checked="" type="checkbox"/>	<input type="checkbox"/>	CH_A	<input checked="" type="checkbox"/>	<input checked="" type="checkbox"/>	1000	0 0 0 0 0 0 0	0x00 0x00 0x00 0x00 0x00 0x00 0x00 0x00 0x00 0x00 0x00 0x00 0x00 0x00 0x00 0x00 0x00 0x07 0x80 0x00	Keep Alive
0x4A8	<input type="checkbox"/>	<input checked="" type="checkbox"/>	<input type="checkbox"/>	CH_A	<input checked="" type="checkbox"/>	<input checked="" type="checkbox"/>	1000	64 0 0 0 0 0 0 0 0 0 0 0 0 0 0 0 0 0 0 0 7 128 0	Set Parameter	

Step 3 (option 1) - To save it as a file to be able to be loaded into SLSS CANAnalyser main program Standalone Send Mode tab, select the .CASF format option as the **Save as type** and then choose a file name

Step 3 (option 2) - To save it as a file to be able to be loaded into SLSS CANAnalyser main program Standalone Send Mode tab, select the .CSSF format option as the **Save as type** and then choose a file name

6.5. Playback Graphical Analyser from the Data Viewer

The selected ID will be displayed in the graphic viewer. Note that this operates identically to how the primary graphical analyser works from the main software. Refer to the other chapter for the details instructions.

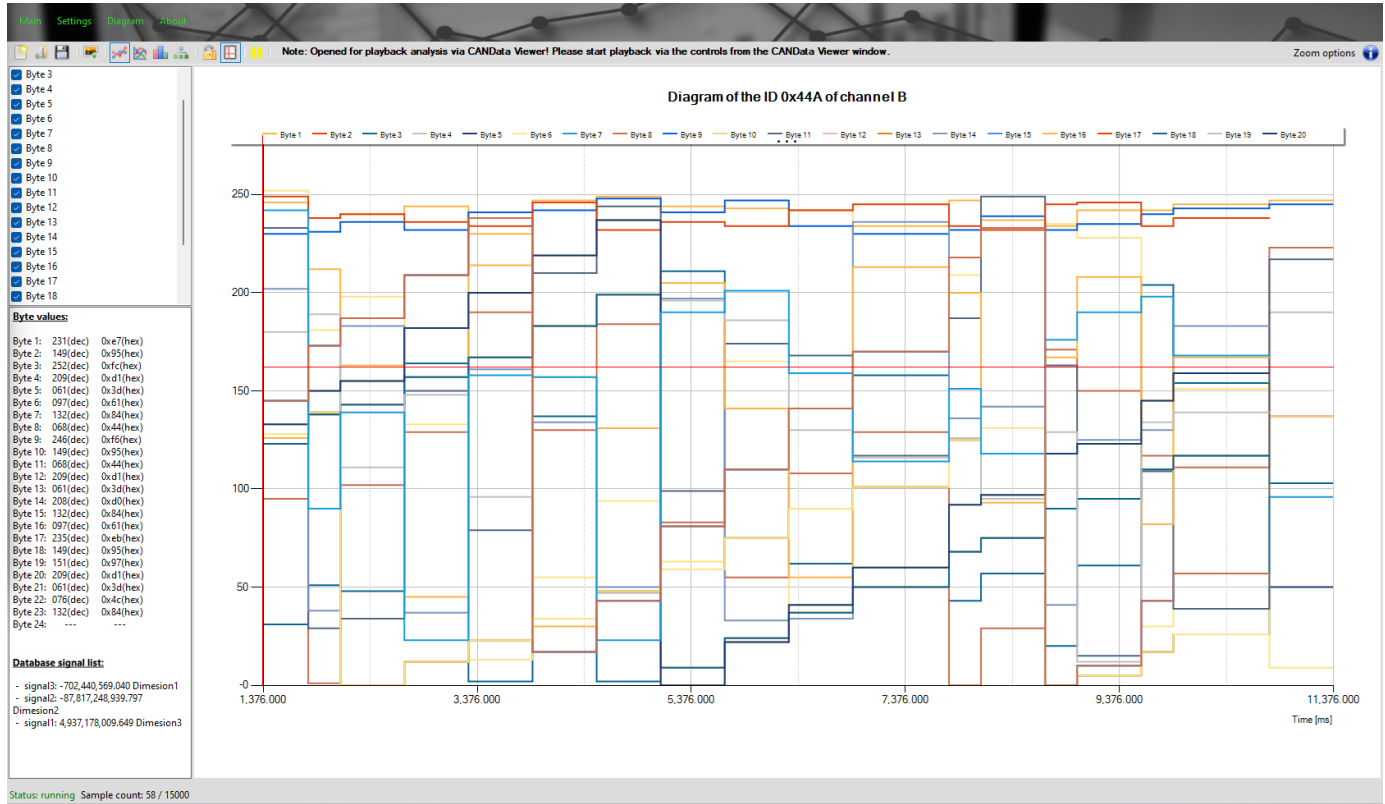

For this graphical analyser to play back the data, the PLAY button must be pressed in the SLSS CANData Viewer or else the graph will not display.

7. TCP/IP Communication Interface for Third-party applications

Using the TCP Interface, data can be passed to a third party application via TCP/IP network connection allowing CANAnalyser to be used as a server that can support multiple connected clients.

This makes it possible to create your own proprietary interface in scripting languages widely used in development, such as Python, Groovy or Lua, and to interface with the SLSS CANAnalyser software to control various functions and analyze the CAN data using a custom remote interface.

For an up to date list of currently supported functions via TCP/IP interface to the SLSS CANAnalyser software, please follow this link: <https://serosys-tech.com/tcp-ip-commands/>



Example Python examples are available to download and contained within the Python Class download here: <https://serosys-tech.com/downloads/#tab-28493>

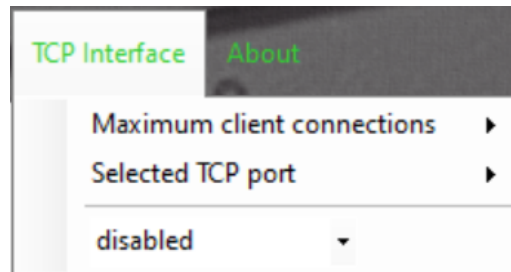

TCP/IP can support multiple connections so the user may specify the maximum number of connections are allowed to be accepted to the software. If the number is increased, the server opens the given number of network ports, starting from the port that gets defined. It is possible to open and stay connected simultaneously on different ports.

The user must then specify the TCP port to be forwarded on the router to open up for the IP address.

This interface may be enabled or disabled.



If the hardware dongle is disconnected during a TCP request, the CANAnalyser software will report a connection error

8. Hardware Dongle Firmware Updater

This menu option feature is used to update the firmware on your hardware dongle if required. To check to see if there is a required firmware update, follow this process.



Please press the "Disconnect" button before loading the SLSS HardwareSuite

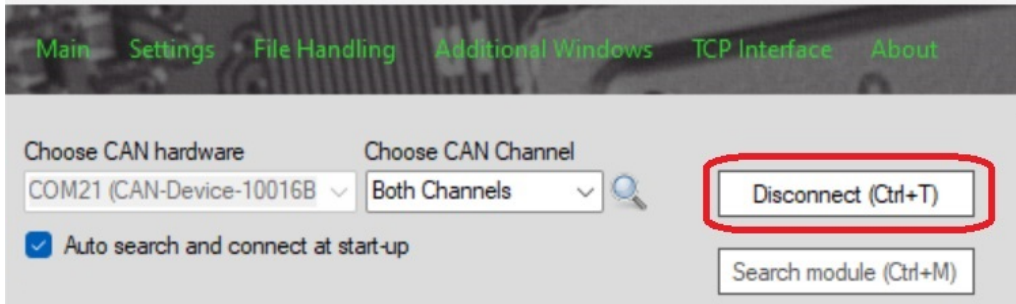

Select "SLSS HardwareSuite" from the "About" menu.

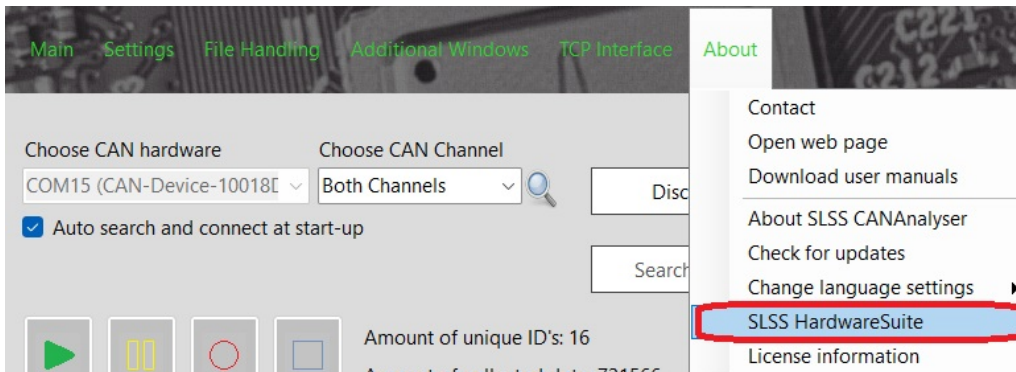

SLSS HardwareSuite V1.1.0.10

Main Update hardware list

SeRoSys Hardware Overview

- Desk CAN Pro (COM46)
 - Hardware serial no: 10018D230915
 - Installed firmware version: 1040
 - Available firmware version: 1040
 - Firmware status: No update required**
- Desk CAN Starter (COM54)
 - Hardware serial no: 10015B230915
 - Installed firmware version: 1037
 - Available firmware version: 1037
 - Firmware status: No update required**

Hardware Update Information

Update for Pocket CAN and Desk CAN Starter devices:

- Latest available software version: 1037
- Build date of latest version: 11/2023
- Included software version: 1037

Update for Desk CAN and Desk CAN Pro devices:

- Latest available software version: 1040
- Build date of latest version: 04/2024
- Included software version: 1040

SLSS CAN Education Program:
 The SLSS CAN Education Program gives teachers, pupils and students the opportunity to use the SLSS CANAnalyser with free hardware, such as Arduino, ESP8266 and ESP32. For more information visit us at SeRoSys-Tech.com.

Update Instructions

- 1) Plug in the device and wait until the device search is completed.
- 2) Make sure that no other program has established a connection to the device.
- 3) Select the device to be updated from the hardware list and click on it.
- 4) In the opened context menu, select the menu item "Update hardware".
- 5) The update process is carried out automatically.

Attention: The connection to the device must not be interrupted during the update process. An interruption can lead to the update being aborted and the device failing completely!

Emergency recovery: If unexpected errors occur during the update process and the device is no longer recognized after the update, there is the option of an emergency recovery. For security reasons, this can only be done by generating an activation token and requires contacting the SeRoSys support.

INFO: Searching for connected hardware, please wait...
 INFO: 1 connected device was found...
 INFO: Hardware changes detected - updating hardware list, please wait...
 INFO: 2 connected devices were found...

When the HardwareSuite loads, after a few seconds, the Hardware Overview will show you the dongle that is plugged in and it will show the firmware status. If the firmware status is green then no update is required and the HardwareSuite may be exited. If the firmware status is yellow, that means there is an update required. Click on the yellow firmware status and follow the instructions.



Please read all the Hardware Update Information on the right side of the screen and follow the directions carefully. If there is a hardware technical issue or the dongle is disconnected during the update process and becomes unresponsive then contact SeRoSys technical support for assistance.

9. Troubleshooting

9.1. PC System resources

Check Task Manager

Too many open programs may have implications on available system resources such as memory and CPU availability and may cause poor performance of the tool:

- Open Task Manager and look for heavy users of system resources and shut down unneeded applications.
- Ideally you must have 16GB of RAM or more, however, ensure a minimum of 8GB of RAM is installed on the target PC

Display Issues

If the program has issues where the display of the tabs are cut off or columns appear truncated, a recommended resolution of 1920 x 1080 at 125% scale is suggested. **Scale settings over 150% are not supported**

9.2. Wiring and Hardware setup

Check wiring

If the dongle is connected properly to the SLSS CANAnalyser and there is no Incoming data, it may be caused by a wiring issue or a USB cable issue.

- Verify proper pinout for interfacing to the DB9 connector in the section titled "Connector Pinouts". **Make sure the polarity is correct for CAN H and CAN L.**
- Look for any loose, shorted or damaged wiring, especially in long buses.
- Verify that the ground is shared between all CAN nodes.
- Ensure that the USB cable is a USB 2.0 oS
- Ensure the bus is properly terminated with 120-ohm resistors at both ends of the bus.

If the dongle has no LEDs lit up at all then the dongle is either not receiving proper power or the dongle is defective.

- Ensure USB cable is tested as a good cable.

- If using the DB9 to power the dongle on **Storage CAN** or **Lab CAN**, verify >7VDC is applied to pin 9.

Noise issues

If the dongle is connected properly to the SLSS CANAnalyser and there are erroneous or unexpected or missing data showing, there may be a noise issue.

- If the bus is too long or not shielded properly, it may pick up noise.
- Implement twisted pair wiring for High and Low pins per channel to reduce noise.

Matching bus types

If the dongle is connected properly to the SLSS CANAnalyser and there is no Incoming data or only partial CAN 2.0 data, it may be caused by a mixture or mismatch of CAN 2.0 and CAN FD nodes.

- Ensure all nodes are using either CAN 2.0 or CAN FD-compliant nodes, as mixing CAN 2.0 and CAN FD nodes may cause unexpected results.
- IF CAN FD is required, ensure all nodes' controllers are CAN FD-compatible. CAN 2.0 controllers may misinterpret CAN FD messages, leading to errors.
- CAN 2.0 nodes are not compatible with CAN FD higher data rates

9.3. Dongle Hardware Configuration



A bus with CAN 2.0 only nodes is very forgiving on the hardware connection configuration settings, however a bus with CAN FD and especially with bit rate switch is extremely sensitive to precise configuration so please verify the settings carefully!

Check arbitration bitrate setup

- Ensure that all nodes on the bus are configured to use the same nominal arbitration bit rate.
- Typical rates: 500 kbit/s or 1 Mbit/s.

Check data bit rate setup (CAN FD only)

- Verify that the bit rate setting matches the target bus configuration
- Ensure that the data bit rate multiplier is properly configured (usually a multiple of the nominal bit rate).

Verify if manual settings are required or not (CAN FD only)

- When not using the manual settings, set the multiplier to provide the correct data bitrate. *Eg. Arbitration bitrate of 500 kbit/s with a multiplier of x8 equals 4000 kbit/s data bitrate*
- When not using the manual settings, note that the sample point percentage is a default of 75%. Use manual settings if another sample point is required.

Synchronize timing segments (CAN FD only when activating the manual settings)

- For both arbitration and data bitrates, adjust prescalers, PSEG1, PSEG2, SJW and TDC to optimize bus performance based on network size and wire length.
- Check sample point settings to avoid improper sampling of the signal.
- **Setting these improperly may cause unexpected problems and may even cause the bus to crash or go into bus off mode**

Specific other hardware configuration issues

Other causes of data not being seen in the Incoming CAN Data tab may be caused by one of these settings

- If bus interaction mode is set to **off**
- Incorrectly configuring the configurable termination resistor setting. A bus must be properly terminated with 120-ohm resistors at both ends of the bus so if interfacing to an existing terminated bus, set them to **disabled**, otherwise ensure they are **enabled**. CAN FD buses are more sensitive to this setting so be cognizant of this setting

If trying to send messages in the Send CAN Messages tab does not produce the actual messages being sent on to the bus, it may be disabled in the hardware configuration

- Ensure that the Send CAN messages are **enabled**.

9.4. Bit Rate Switch (BRS) Issues

If interfacing to a CAN FD bus that used bit rate switch messages, extra care is required to avoid bus crash issues and missed messages.

Mixed BRS modes on the same bus

- Ensure that all nodes are set to either use or not use BRS. Mixing nodes with BRS enabled and disabled can cause arbitration issues.
- Do not add send messages with the same ID having CAN FD bit rate switch and without bit rate switch

9.5. Diagnosing Specific Issues

Bus Off Errors

- This occurs when a node repeatedly fails to transmit or receive messages. If this occurs, try to reconnect the dongle to see if the dongle settings were the cause. If this does not work then the bus off error is caused by another node on the bus.

Only Channel A in available and certain features are not available

- If the drop-down menu is greyed out or you cannot select Channel B, the license file does not match the hardware dongle connected to it!
- Similarly, if certain features are not available, the license file does not match the hardware dongle connected to it!

10. Appendix / References

PEAK™ .TRC V2.0 and V2.1 formats supported from PEAK™ through their PCAN® software.
<https://register.dpma.de/DPMAreister/marke/register/397181558/DE>